

## Engineering Sheet

Job Name \_\_\_\_\_

Contractor \_\_\_\_\_

Job Location \_\_\_\_\_

Approval \_\_\_\_\_

Engineer \_\_\_\_\_

Contractor's P.O. No. \_\_\_\_\_

Approval \_\_\_\_\_

Representative \_\_\_\_\_

# LEAD FREE\*

## Series PVS-7000 Flood Protection Backflow System with SentryPlus Alert™

Watts Flood Protection Backflow System with SentryPlus Alert™ is a configured water flow control system that is assembled from proven, reliable components to meet exacting project application requirements. Watts connected Flood Protection Shutdown ACV coupled with an industry-leading Backflow Preventer helps protect against catastrophic property damage that can occur due to Relief Valve discharge and/or a blocked or overwhelmed floor drain. These drop-in valve stations are factory pre-assembled and tested, ensuring quality and flow performance for critical building demands.

The Series PVS-7000 features integral SentryPlus Alert™ technology to provide multi-channel alerts to notify you in real time if there is an issue so you can take appropriate action. Alerts can be a text, email, or phone call.

### Standard Features

- Helps protect property by shutting off supply to the backflow preventer and alerting the user remotely in case of possible catastrophic flood condition.
- Avoid potentially costly losses arising from flooding and property damage, including higher insurance premiums and expensive mop up operations.
- Reduce the need for off-hour maintenance personnel, as the smart system not only detects the failure but also takes preventive action of shutting down the line and alerting the end-user via email, phone, text message (or all three) remotely via the SentryPlus Alert™ system, or through connection to a Building Management System (BMS).
- Ideal for medium to large line sizes up to 10".
- UL/FM, ASSE, IAPMO, and USC certified or listed components as required for service

### Functional Specifications

**Operating Pressure:** 175psig

**Operating Temperature:**

- 957 Backflow: 33°F – 140°F
- LF909 Backflow: 33°F-110°F continuous, up to 140°F intermittent

**Hydrostatic Test Pressure:** 350psig

**End Connections:** 150# Flanged

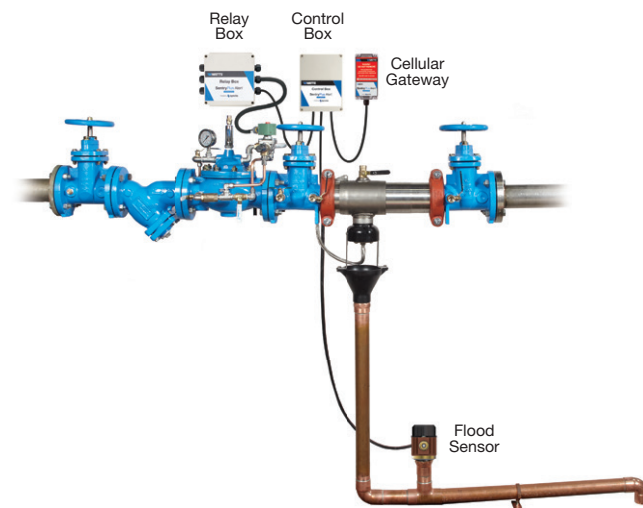

### Agency Approvals for Backflow Assemblies only

- Approved by the Foundation for Cross-Connection Control and Hydraulic Research at The University of Southern California (FCCCHR-USC)
- ASSE 1013 Listed
- \*\*UL Classified (US & Canada)
- \*\*FM Approved
- AWWA Standard C511 Compliant
- End connections compliant to ASME B16.1 Class 125 a& AWWA Class D Flange
- NSF certified to NSF/ANSI 61-G

#### NOTICE

These are the standard approvals for the Watts 957 and LF909 backflow assemblies, and are for reference only. For full list of approvals and details, please reference the relevant backflow specification on Watts.com

\*\*Assembly configured with UL/FM Approved OS&Y and BFG valves. Less valve or NRS assemblies are not UL/FM approved configurations.

#### NOTICE

The information contained herein is not intended to replace the full product installation and safety information available or the experience of a trained product installer. You are required to thoroughly read all installation instructions and product safety information before beginning the installation of this product.

\*The wetted surface of this product contacted by consumable water contains less than 0.25% of lead by weight.

Watts product specifications in U.S. customary units and metric are approximate and are provided for reference only. For precise measurements, please contact Watts Technical Service. Watts reserves the right to change or modify product design, construction, specifications, or materials without prior notice and without incurring any obligation to make such changes and modifications on Watts products previously or subsequently sold.

## NOTICE

Use of the Watts Smart Flood Protection Shut Down Valve with SentryPlus Alert™ Technology does not replace the need to comply with all required instructions, codes, and regulations related to the installation, operation, and maintenance of an RPZ backflow preventer, including the need to provide proper drainage in the event of a discharge.

Watts is not responsible for the failure of alerts due to connectivity or power issues.

## Available sizes

Size: 2½ - 10"

## Available Backflow Preventers

957  
LF909

## Available Shutoff Valves

OSY  
NRS

Optional strainer w/downstream shutoff available, shipped separately

## Typical Installation

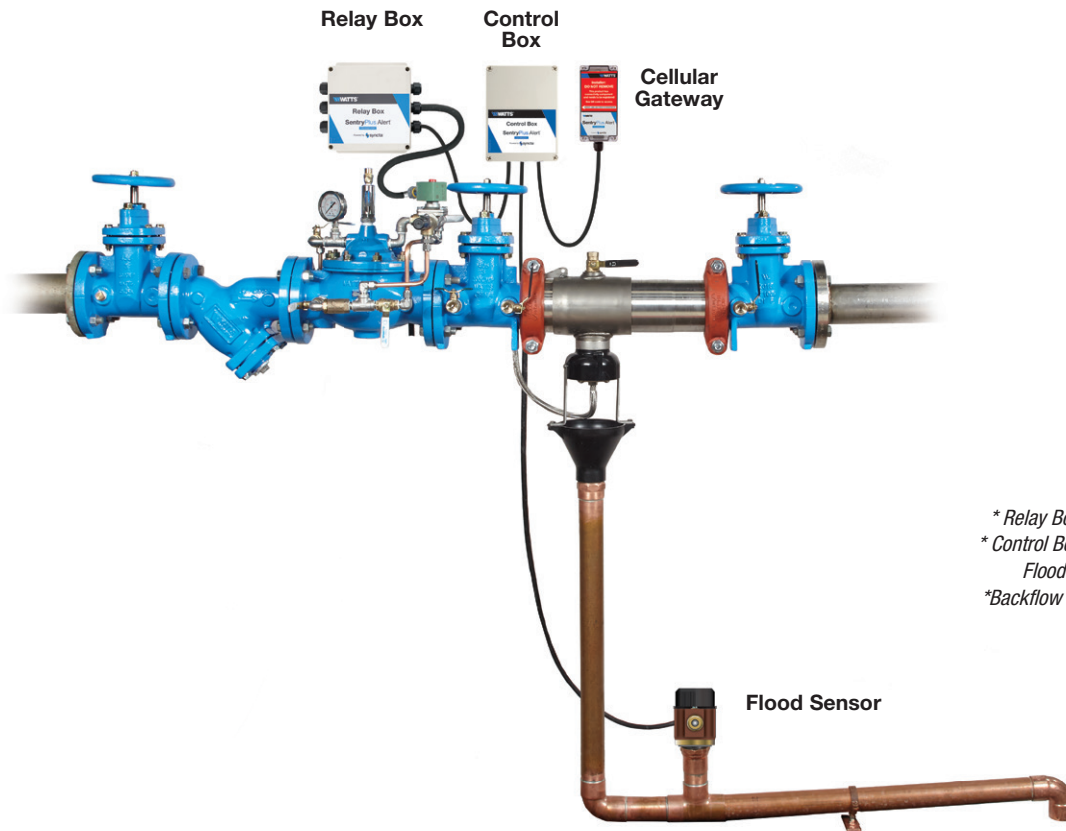

*\* Relay Box Ships Valve Mounted  
\* Control Box, Cellular Gateway, and  
Flood Sensor Ship Loose  
\* Backflow Illustration is 957 Series*

## Operation

The Watts smart and connected Engineered Flood Protection Valve Station with SentryPlus Alert™ helps protect against catastrophic property damage that can occur due to Relief Valve discharge and/or a blocked/undersized floor drain during normal relief valve operation. Typical conditions which can cause continuous relief valve discharge are:

- Fouled First Check Seat due to dirt, debris, or rocks
- Failed First Check Spring
- Clogged or blocked Relief Valve Sensing Line
- Relief Valve Diaphragm failure

The Watts LFF113FP Flood Protection Shutdown Valve is a normally open valve designed to be installed upstream of a Reduced Pressure Zone (RPZ) Backflow Prevention device. It is normally open and closes when continuous relief valve discharge through the drain pipe is sensed by the Flood Sensor, energizing the Relay Box and Solenoid Pilot.

The valve is equipped with a Solenoid By-Pass valve (normally closed) which manually closes the Main Valve when engaged. The Control Box is equipped with an adjustable time delay to avoid valve closure due to intermittent or nuisance relief valve discharge. The Position Indicator provides local, visual indication of valve closure and is useful during valve start-up and troubleshooting. The valve remains closed and cannot re-open if flow stops or electrical service is interrupted, and must be manually reset after the RPZ is diagnosed and/or repaired.

The shutdown valve comes complete with the Relay Box, pre-wired Solenoid Valve, Manual Reset with Pressure Gauge, Position Indicator and Flood Sensor (field installed). The SentryPlus Alert™ Control Box and Cellular Gateway ship loose with 6 feet of interconnecting cable and must be field mounted.

For more details refer to the LFF113FP, SentryPlus Alert Technology, and the relevant backflow preventer ES sheets on [watts.com](http://watts.com)

## Technical Specifications

### Connected Valve Stations with 957 Backflow and ACV:

The Reduced Pressure Zone Assembly shall consist of two independent torsion spring check modules, a differential pressure relief valve located between and below the two modules, two drip tight shutoff valves, and required torsion spring check modules and relief valve shall be contained with a sleeve accessible single housing constructed from 304 (Schedule 40) stainless steel pipe with groove end connections. Torsion spring checks shall have replaceable elastomer discs and in operation produce drip tight closure against the reverse flow of liquid caused by backpressure or backsiphonage. Assembly shall be a Watts Series 957.

The Flood Protection Shutdown Valve shall be a normally open Diaphragm Valve installed upstream of the Reduced Pressure Zone (RPZ) Backflow Assembly, and automatically close if the RPZ relief valve begins to discharge. A Time Delay supplied in the Control Box shall prevent the valve from closing on intermittent discharges from the RPZ relief valve. Once closed the ACV must be manually reset. The Relay Box on ACV connects to SentryPlus Alert™ Control Box, which is also connected to the Cellular Gateway for wireless communication alerting the user via text, phone, or email. This communication is via cellular network using Watts Syncta Cloud IoT platform. Control box is a remote mounted, 120VAC powered unit. Cellular Gateway is a remote mounted unit and can be mounted up to 100ft away from the Control Box. Extra set of Remote Trip Indication terminals on the Control Box allow users to get remote alarms at their Building Management System (BMS) / PLC controller in the Control Room. The entire Valve station assembly shall be provided by the same manufacturer and be covered by a single warranty policy.

### Connected Valve Stations with LF909 Backflow and ACV:

A Reduced Pressure Zone Assembly shall be installed at each cross-connection to prevent backsiphonage and backpressure backflow of hazardous materials into the potable water supply. The assembly shall consist of a pressure differential relief valve located in a zone between two positive seating check valves and captured springs. Backsiphonage protection shall include provision to admit air directly into the reduced pressure zone via a separate channel from the water discharge channel. The assembly shall include two tightly closing shutoff valves before and after the valve and test cocks. The Lead Free\* Reduced Pressure Zone Assembly shall comply with state codes and standards, where applicable, requiring reduced lead content. The assembly shall meet the requirements of ASSE Std. 1013; AWWA Std. C511-92; CSA B64.5; and UL Classified File No. EX3185. Listed by IAPMO (UPC). Approved by the Foundation for Cross Connection Control and Hydraulic Research at the University of Southern California. The assembly shall be a Watts Series LF909.

The Flood Protection Shutdown Valve shall be a normally open Diaphragm Valve installed upstream of the Reduced Pressure Zone (RPZ) Backflow Assembly, and automatically close if the RPZ relief valve begins to discharge. A Time Delay supplied in the Control Box shall prevent the valve from closing on intermittent discharges from the RPZ relief valve. Once closed the ACV must be manually reset. The Relay Box on ACV connects to SentryPlus Alert™ Control Box, which is also connected to the Cellular Gateway for wireless communication alerting the user via text, phone, or email. This communication is via cellular network using Watts Syncta Cloud IoT platform. Control box is a remote mounted, 120VAC powered unit. Cellular Gateway is a remote mounted unit and can be mounted up to 100ft away from the Control Box. Extra set of Remote Trip Indication terminals on the Control Box allow users to get remote alarms at their Building Management System (BMS) / PLC controller in the Control Room. The entire Valve station assembly shall be provided by the same manufacturer and be covered by a single warranty policy.

## Dimensions

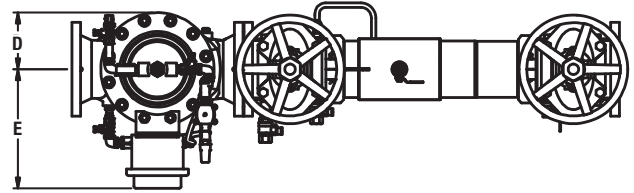
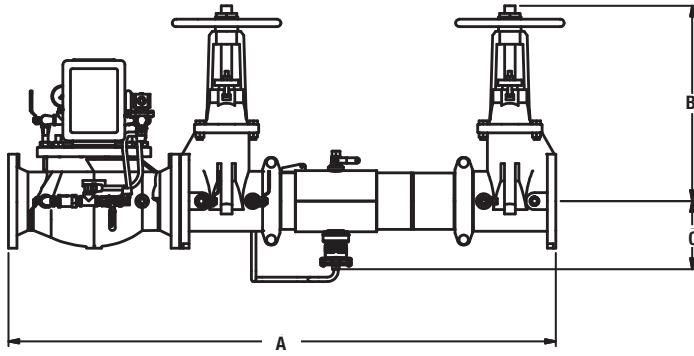

### 957 Backflow and ACV Dimensions

MODEL SIZE	DIMENSION (approximate)										WEIGHT (NRS)		WEIGHT (OSY)			
	A			B (NRS)		B (OSY)		C		D		E		lbs.	Kg	lbs.
2½	41¾	1060	9¾	238	16¾	416	6½	165	9¼	230	11	279	183	83	193	88
3	43¾	1137	10¼	260	18¾	479	6⅞	170	9⅞	230	11¾	289	229	104	243	110
4	48¾	1238	12¾	310	22¾	578	7	178	14¾	365	12¼	311	354	161	354	161
6	63½	1613	16	406	30¾	765	8½	216	14¾	365	14	356	596	270	618	280
8	75½	1908	19½	506	37¾	959	9⅞	246	19¼	489	15¼	400	1091	495	1133	514
10	87½	2223	23¾	605	45¾	1162	11¾	285	21	533	18¾	473	1693	768	1753	795

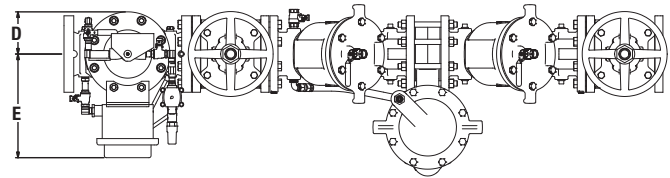
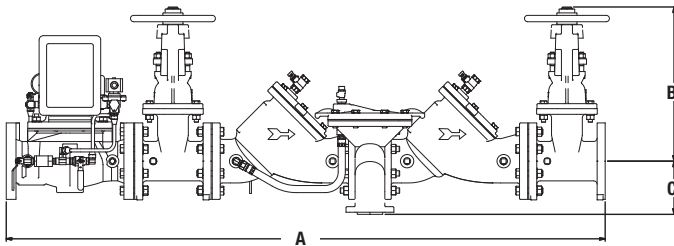

### LF909 Backflow and ACV Dimensions

MODEL SIZE	DIMENSION (approximate)										WEIGHT (NRS)		WEIGHT (OSY)			
	A			B (NRS)		B (OSY)		C		D		E		lbs.	Kg	lbs.
2½	48¾	1238	9¼	259	16¾	416	5¼	133	9¼	230	11	279	260	118	263	119
3	50¼	1276	10¼	289	18¾	479	5¼	133	9¼	230	11¾	289	320	145	325	147
4	64¾	1629	12½	352	22¾	578	6	152	14¾	365	12¼	311	645	293	660	299
6	76	1930	16¾	470	30¾	765	6	152	14¾	365	14	356	1038	471	1082	491
8	90	2286	20¾	575	37¾	959	9¾	248	19¼	489	15¼	400	2000	907	2106	955
10	106¾	2708	23¾	657	45¾	1162	9¾	248	21	533	18¾	473	3130	1420	3200	1451

### Optional Strainer w/Shutoff Dimensions

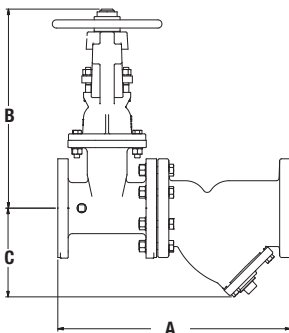

MODEL SIZE	DIMENSION (approximate)										WEIGHT (NRS)		WEIGHT (OSY)	
	A			B (NRS)		B (OSY)		C		D		lbs.	Kg	lbs.
2½	17½	446	9¾	238	16¾	416	6½	165	57	26	83	38		
3	18¾	460	10¼	260	18¾	479	7	178	74	34	104	47		
4	21½	536	12¾	310	22¾	578	8¼	210	122	55	160	73		
6	29	737	16	406	30¾	765	13½	343	206	93	245	111		
8	33¾	841	19½	506	37¾	959	15½	394	327	148	383	174		
10	39	991	23¾	605	45¾	1162	18 ½	470	519	235	647	293		

## Ordering Information

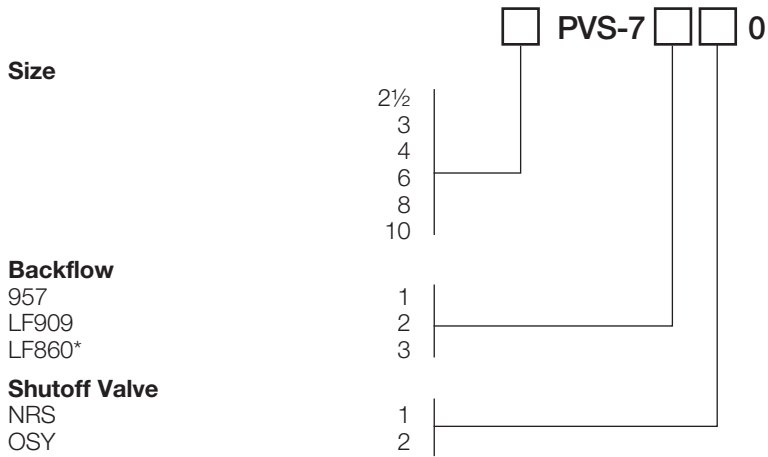

\*See [www.febcoonline.com](http://www.febcoonline.com) for details on the PVS-7000 with the LF860 backflow preventer

**Example:** A 4" Valve Station with a LF909 backflow preventer and NRS shutoffs would be a **4 PVS-7210**

### For optional strainer

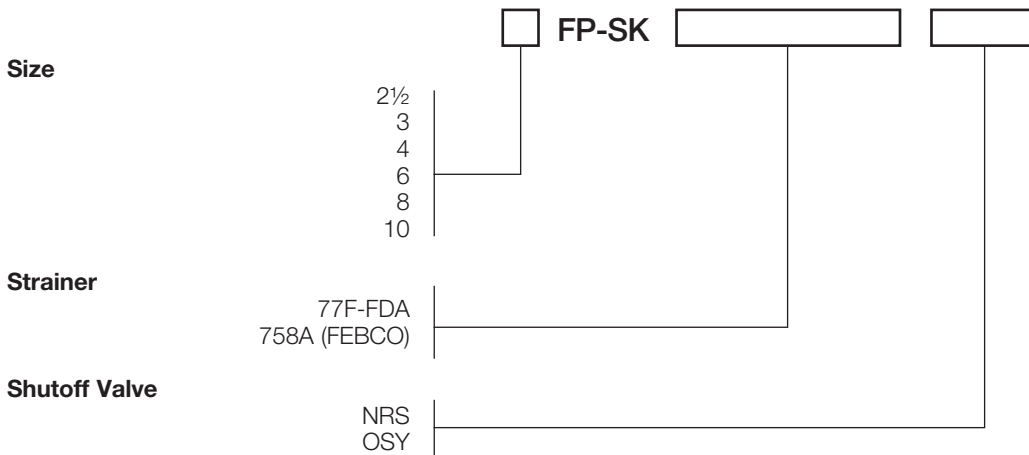

**Example:** A 6" 77-FDA strainer with OSY shutoff would be a **6 FP-SK-77F-FDA-OSY**



**USA:** T: (978) 689-6066 • F: (978) 975-8350 • [Watts.com](http://Watts.com)  
**Canada:** T: (905) 332-4090 • F: (905) 332-7068 • [Watts.ca](http://Watts.ca)  
**Latin America:** T: (52) 55-4122-0138 • [Watts.com](http://Watts.com)