

Instructions for Operation and Maintenance

MCX - Model No 28056

Monochloramine Analyzer

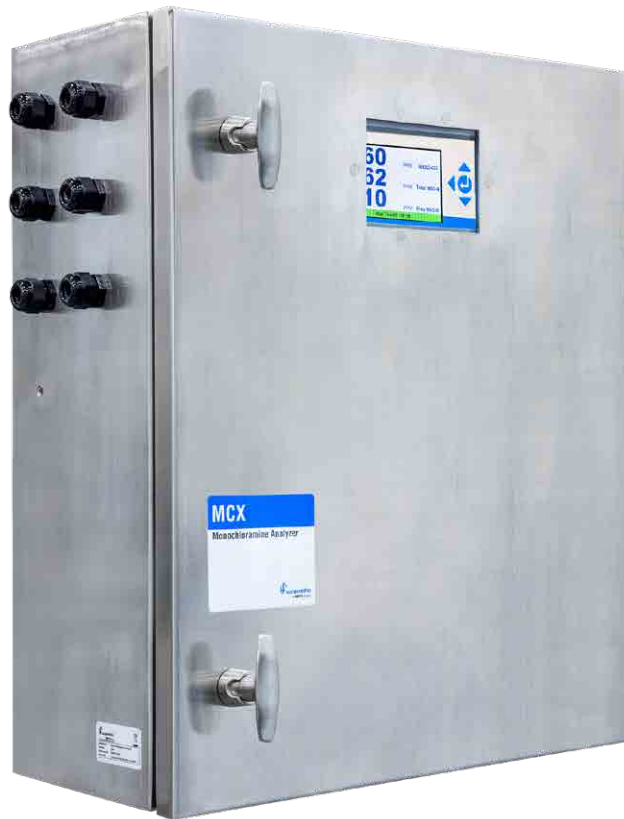



Table of Contents

Understanding Safety Information	3	Modbus Configuration	13
Introduction to the Unit	4	Coils	13
Overview	4	Valid Command(s)	13
Specifications	4	Format	13
Unpacking and Inspection of the Instrument	4	Valid Addresses	13
Instrument Labels	4	Definitions	13
Display	4	Input Status	13
Installation	4	Valid Commands	13
Site Selection and Mounting	4	Format	13
Plumbing Connections	5	Valid Addresses	13
Electrical Connections	5	Definitions	13
Electrical Wiring Requirements	5	Input Registers	13
Local Disconnect	5	Valid Commands	13
Low Voltage Connections	5	Format	13
Alarms	5	Valid Addresses	13
Modbus	5	Definitions	13
Securing the Glands - Low Voltage	5	Holding Registers	14
Mains Power Connections	6	Valid Commands	14
Securing the Electrical Enclosure	6	Format	14
Commissioning and Start-Up	6	Valid Addresses	14
Measurements	6	Definitions	14
Instrument Configuration	6	Exception Responses Implemented	14
Selecting the Analog Output	7	Maintenance	14
Setting the Units of Measurement	7	Calibration	14
Setting the Date/Time	7	Verification/External Grab Sample	15
Adjusting the Brightness	7	Maintenance	16
Screen Saver Timeout	8	Cuvette Cleaning	16
Setting the Time Between Measurements	8	Heater Scale Removal Procedure	16
Adjusting the Line Flush Duration	8	Replacing the Complete Tubing Kit (#28182S)	16
Modbus Address	8	Replacing the Reagent Pump (Kit #28181S)	17
Diagnostics	9	Replacing the Peristaltic Pump (Kit #28141S)	17
Security Setting	9	Replacing the Pressure Regulator Assembly (Kit #28158S)	17
Clear Errors and Warnings	9	Replacing the Air Pump (Kit #28164S)	18
Firmware Update	9	Replacing the Cap and Inlet Tubing (Kit #28179S)	18
Copying FRAM data to Micro-USB	10	Replacing the Thermocouple (Kit #28180S)	19
Instrument ID	10	Replacing the Heater (Kit #28172S)	19
Data Resolution	11	Accessories and Replacement Parts List	20
Factory Reset	11	Troubleshooting	21
About Device	11	Operational	21
Offsets	11	Halting Errors	21
Alarms	11	Non-Halting Errors	23
Signal Averaging	11	Warranty	24
System Start Up	12		
Prepare Reagents	12		
Priming the MCX	12		
Taking Readings	12		

Understanding Safety Information

This manual contains safety and use instructions that must be followed during the installation, commissioning, operation, care and maintenance and service of the MCX. All responsible personnel must read this manual prior to working with this instrument and should familiarize themselves with the following safety symbols, signals and pictorials.

⚠ WARNING	
	Read this Manual BEFORE using this equipment.
	Failure to read and follow all safety and use information can result in death, serious personal injury, property damage, or damage to the equipment.
	Keep this Manual for future reference.



This is a safety-alert symbol. The safety alert symbol is shown alone or used with a signal word (DANGER, WARNING, or CAUTION), a pictorial and/or a safety message to identify hazards.

When you see this symbol alone or with a signal word on your equipment or in this Manual, be alert to the potential for death or serious personal injury.



This pictorial alerts you to the need to read the manual.



This pictorial alerts you to electricity, electrocution, and shock hazards.



This symbol identifies hazards which, if not avoided, will result in death or serious injury.



This symbol identifies hazards which, if not avoided, could result in death or serious injury.



This symbol identifies hazards which, if not avoided, could result in minor or moderate injury.



This symbol identifies practices, actions, or failure to act which could result in property damage or damage to the equipment.

Introduction to the Unit

Overview

The MCX (Monochloramine Analyzer) has been specially designed to measure and report the concentration of Monochloramine and Ammonia dosing in water samples over specified ranges. The instrument uses the modified phenate method to test for Monochloramine and Ammonia.

Specifications

Measurement Range	0.02 to 2.0 mg/L as N
-------------------	-----------------------

NOTICE

Specifications listed are based on installation/operation at sea level.

Accuracy	±5% or 0.01 ppm (as N) for 16°C to 40°C (61°F to 104°F); ±10% or 0.02 ppm for 40°C to 50°C (104°F to 122°F), whichever is greater
Repeatability	±3% RSD
Time Between Measurements	20 minutes to 24 hours
Display	5" color graphic
Alarms	Two, not powered relays
Communication	Modbus RS485, 4-20mA Output
Operating Humidity	5 to 95%, non-condensing
Operating Temperature Range	16°C to 50°C (41°F to 122°F)
Output	Three 4-20mA Outputs, 1000 Ω drive, isolated
Power Requirements (Hz)	47/63 Hz
Power Requirements (Voltage)	100 - 240 VAC
Sample Flow Rate	185 ml/min. to 225 ml/min. (.044 to .059 Gal/min)
Sample Pressure	124 kPa (18psi) MAX (see Plumbing Connections section)
Sample Temperature	5°C - 50°C (41°F - 122°F)
Storage Condition	-20 to 60°C (-4 to 140°F), Drained
Wetted Materials	BPT, Polypropylene, 316 Stainless Steel, Viton, Noryl®, Resyln, Borosilicate Glass, PPS, PVDF (Kynar), Fluoroelastomer, Acetal, Nitrile. Additional materials when using the external brass regulator: Bronze, Polyethylene, 304 Stainless Steel, Brass, EPDM, PTFE, Rubber.
Insulation Rating	Double Insulated, Pollution Degree 2, Overvoltage Category II
Enclosure Rating	NEMA 4X
Regulatory Compliance And Certifications	UL, cULus, Lead Free, tested to UL 61010-1 and CSA C22.2
Shipping Weight	88.6 pounds (packaged instrument)



Unpacking and Inspection of the Instrument

Remove all items from packing carton and carefully inspect to ensure that no visible damage has occurred during shipment and that all items listed below have been received. If the items received do not match the order, please contact your local distributor or the HF scientific Customer Service department.

- MCX - Monochloramine Analyzer
- Inlet Assembly
- Reagent/Air Flush Kit
- Instruction Manual
- Chemical Reagents, shipped separately

Instrument Labels

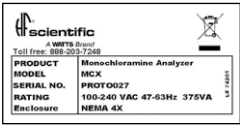
The following labels should be applied to the outside of the enclosure.

Purpose	Location	Label
Serial number, manufacturer, part number, power rating, UL marking	Side of Unit	
Informational	Front of Unit	

Display

- 1 - Exit Button
- 2 - Mode Button
- 3 - Date/Time of last NH₂Cl-Cl₂ reading
- 4 - Date/Time of last Total NH₃-N reading
- 5 - Date/Time of last Free NH₃-N reading
- 6 - Cycles through current instrument status, warnings (yellow), errors (red). If instrument is operating as normal, background will be green.
- 7 - Last NH₂Cl-Cl₂ reading
- 8 - Last Total NH₃-N reading
- 9 - Last Free NH₃-N reading
- 10 - Enter/Save Button

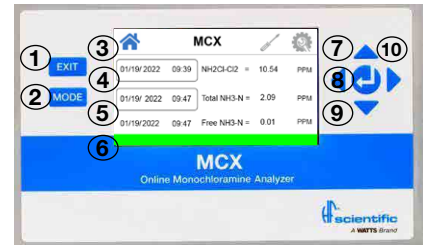

Installation

Site Selection and Mounting

The instrument is designed for wall mounting. Install the instrument indoors, in a non-hazardous environment. The instrument should be mounted at eye level and be easily accessible for operation and service. Consideration must be made for the plumbing and electrical conduit connections. Recommended mounting screws are M8 (5/16") fasteners for the instrument enclosure. The instrument is rated for an altitude of 2000 m (6562 ft) maximum.

It is critical that the instrument be mounted as close as possible to the sampling point to ensure a quick response time (within 2 to 3 meters (6 to 10 feet) of the sampling point). If installation is more than 10 feet away from the sampling point, a fast loop must be installed. The plumbing should be run with a fast loop installed as close to the instrument as possible.

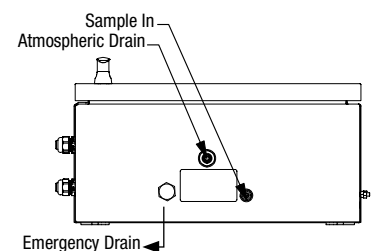
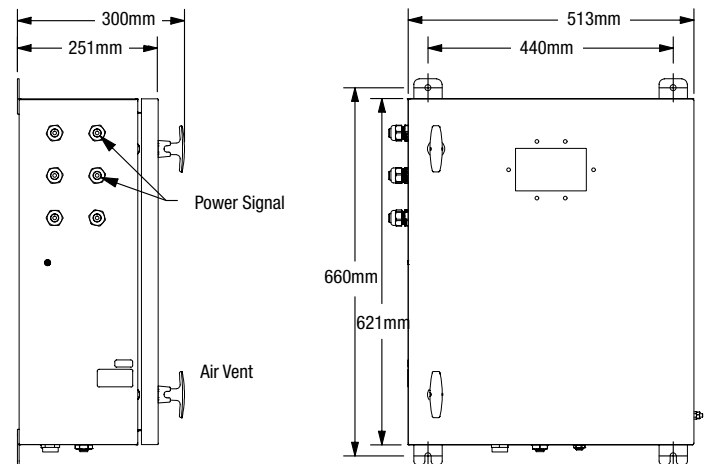

Plumbing Connections

NOTICE

It is recommended to install pressure regulating and relief valves to maintain proper inlet pressure for the instrument. The pressure regulator and relief valve is included with the instrument.

NOTICE

When using this instrument in potable water applications, the drain water from this instrument should NEVER be reintroduced back into the incoming water stream. This water MUST be directed to a convenient drain.

All plumbing connections are made with user supplied tubing using the push to connect fittings attached to the MCX.

- Sample water should be particulate free.
- The sample water supply does not need to be pressurized.
- To ensure that the sample measured is representative, keep the sample pipe run as short as possible.
- A water shutoff valve should be located close to the instrument to allow for periodic maintenance.

1. Connect the sample water line to the MCX using the 1/4" push to connect fitting on the bottom of the enclosure.
2. Connect the main drain line to the MCX using the 3/8" push to connect fitting on the bottom of the enclosure. There is no tubing connection for the emergency drain.

NOTICE

To prevent water flow backup in the instrument, the drain MUST open to atmosphere and must flow freely to drain and contain no loops in the tubing.

Electrical Connections

⚠ DANGER

Installation of this instrument involves line voltage that could endanger life. Only qualified electricians should perform installation of the instrument.

All electrical connections are located in the upper electrical compartment. The electrical compartment can be opened by loosening the Phillips screw to the left of the display screen.

The MCX has two types of electrical connections. First, the mains power connection, which connects to the cable gland on the left side of the MCX. Second, the low voltage connections, which are made through the 2nd gland on the left side of the MCX.

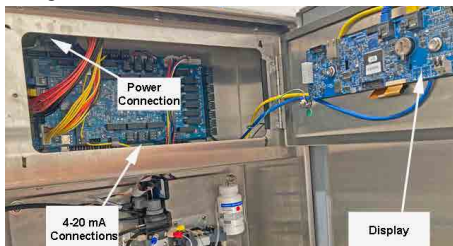

Electrical Wiring Requirements

The MCX is required to be wired to a 15A circuit breaker. The cable should be sized for a 15A supply with all three wires the same gauge.

Local Disconnect

A local two pole disconnect needs to be installed less than 2 meters (6 feet) from the instrument and labeled as the disconnect for the MCX. This allows for emergency disconnect and isolation of the equipment.

⚠ WARNING

All low voltage connections should be completed before the mains power is connected to the system.

Low Voltage Connections

All of the low voltage electrical communication connections to the instrument are made at the termination area located on the middle bottom side of the Main UI board located inside the electrical panel.

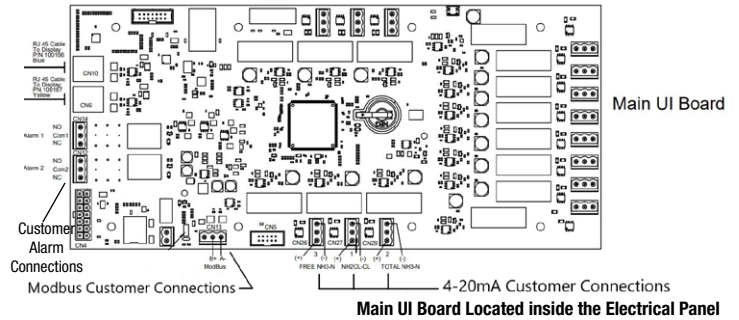

4-20mA Analog Output

To access the connections, open the access panel by loosening the captive Phillips screw. The connections are labeled (CN26 for Free Ammonia, CN27 for Monochloramine, CN28 for Total Ammonia). Upper pin is negative, lower pin is positive. Please follow all government recommendations and requirements for installation of electrical connections to and between the instrument and other peripheral devices.

There are three 4-20mA outputs, one for Monochloramine, one for Total Ammonia and one for Free Ammonia. The 4-20mA output is driven by a 24 VDC power source and can drive recorder loads up to 1000 ohms. **Do not run 4-20 mA cables in the same conduit as power.** Transformer isolation is provided on the MCX. Operation of this output is covered in the Analog Output Menu.

The recommended cable is 22 AWG shielded twisted pair. To prevent ground loops, connect the shield only at its destination. The black terminal block is removable to assist in making connections.

The 4-20mA is factory calibrated. An adjustment can be made using the Analog Output Menu. In addition to making adjustments, these menus output a continuous 4mA or 20mA and can be used as a signal test. The configuration mode will time out after 15 minutes.

Alarms

There are two Form C relay outputs. Their locations are CN14 (Alarm 1) and CN12 (Alarm 2) on the left side of the main UI PCB board, see the wiring diagram for correct pin connection. There are three types of events that will trigger a change in the relay state; Errors, Warnings and End of Cycle. The relay is in the NC position, when an event occurs the NC will open, closing the NO position changing the state of the relay.

Modbus

There is one Modbus output connection available. The RS-485 half-duplex (2-wire) digital interface operates with differential levels that are not susceptible to electrical interferences. Cable lengths up to 900 meters (3,000 ft) can be implemented. The last device on each bus may require terminating with a 120-ohm resistor to eliminate signal reflection on the line. Do not run RS-485 cables in the same conduit as power.

Securing the Glands - Low Voltage

Low voltage connections to the instrument are made through electrical glands located on the left side of the enclosure. Once the appropriate low voltage wiring is inserted through the electrical gland and wiring is secured at the terminals on the Main UI board, the gland on the left side of the enclosure must be tightened to ensure wiring is safely installed.

Mains Power Connections

Once all low voltage connections are made, the mains power should be connected through one of the top glands located on the left side of the enclosure.

The MCX is not supplied with a power cord. A user supplied power cord capable of 120/240V is required. If this needs to be hard wired, the connections are as follows:

- Terminal 3: Earth Ground
- Terminal 2: Neutral
- Terminal 1: Line or Hot

⚠ DANGER

The instrument can accept 100-240 VAC, 47-63 Hz. Verify that the mains voltage falls within these specifications.

Suitable wire would be stranded, 3 conductors 18-12 AWG copper or tin plated copper with a voltage rating of 600 VAC with a temperature rating of 90°C or higher.

Common earth bond points are provided both inside the enclosure on the chassis and outside of the enclosure. This terminal set can be removed for easier connections.

⚠ WARNING

To minimize the risk of receiving an electrical shock, there is an earth stud located outside of the enclosure on the right side. This must be tied to earth before powering up the MCX.

Mains power connection to the instrument is made through an electrical gland located on the left side of the enclosure. Once the mains power wiring is inserted through the electrical gland and wiring is secured at the mains power terminal on the left side of the enclosure, the electrical gland must be tightened to ensure mains power is safely installed. A cable tie down is provided. Route the power cable through the white tie down located on the top left side of the electrical panel and tighten.

Securing the Electrical Enclosure

Once all electrical connections are made, the electrical panel must be secured by closing the compartment and tightening the captive Phillips screw.

Commissioning and Start-Up

- Once all water and electrical connections have been made, turn on water supply and then turn on power to the MCX.
- The MCX will run through a startup process that takes less than 10 seconds.
- The most recent NH₂Cl-Cl₂ and Total NH₃-N readings will be displayed along with the date and time stamps and units. The green banner at the bottom of the screen provides information on when the next reading will occur.

MCX	
01/19/2022 09:39	NH ₂ Cl-Cl ₂ = 10.54 PPM
01/19/2022 09:47	Total NH ₃ -N = 2.09 PPM
01/19/2022 09:47	Free NH ₃ -N = 0.01 PPM

Measurements

This analyzer allows for the measurement of the monochloramine (NH₂Cl-Cl₂) and Total Ammonia (NH₃-N) output from test solution in a water source. Measurements are usually taken in Parts per Million (ppm). The unit can measure monochloramine (NH₂Cl-Cl₂) ranging from 0.02 ppm to 10 ppm and Total Ammonia (NH₃-N) ranging from 0.02 ppm to 2 ppm.

Measurements can be taken in Parts per Million (ppm) or Milligrams per Liter (mg/L).

When a continuous process stream is flowing through the instrument, the instrument will take samples at preset intervals and display the readings on the screen. In addition, the equivalent signal is provided on the analog (4-20 mA) outputs, depending on the options selected.

NOTICE

There is a removable light shield attached to the optical block to help prevent light from entering the optical block which may affect the readings. Be sure this shield is in place at all times when taking readings or doing a calibration to ensure reading accuracy.

Instrument Configuration

The instrument has the ability to be customized at any time during operation. Configuration Mode has been split into sub-menus to facilitate instrument configuration. While in Configuration Mode, the instrument has a time-out feature that automatically returns the sub-menus to the previous screen after a 60 second period. Configuration screens timeout after 60 seconds to the Home screen.

To enter Configuration Mode:

- Press the MODE button on the home screen to enter the Security Menu.
- Using the **▶** button, highlight the number 5. Press the **◀** button until 555555 is shown in the PIN Box. Enter will then be highlighted. Press the **◀** button.

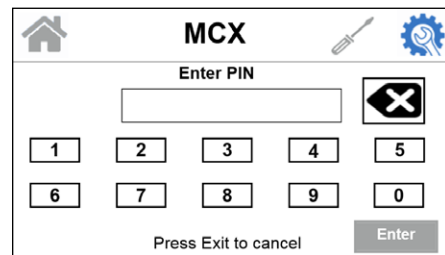

- Press the **◀** button to highlight **Enable Admin** then press the **MODE** button. You should be back to the home screen.

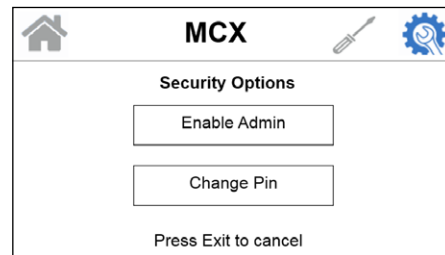

- Press the MODE button again. Sub-menu options are then shown. To move between sub-menus, use the **▲** and **▼** arrows to navigate between sub-menus.
- Press the Exit button to exit the Configuration Menu and return to the home screen.

Selecting the Analog Output

The first configuration sub-menu is Analog Output. There are three analog outputs, one for NH₂Cl-Cl₂, one for Total NH₃-N and one for Free NH₃-N. To span the Analog Outputs:

1. Select **Analog Outputs** from the Configuration Menu.

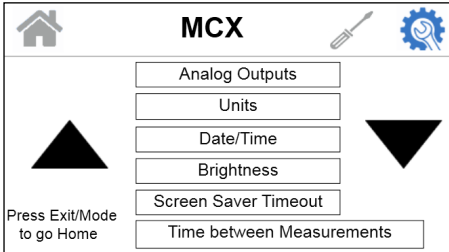

2. Using the ▲ and ▼ arrows, select NH₂Cl-Cl₂, Total NH₃-N or Free NH₃-N to set the corresponding values.

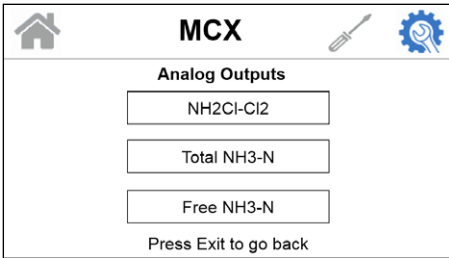

3. Press ↵ to enter the submenu.
4. Using the ▲ and ▼ arrows, navigate to the desired setting and press ↵.

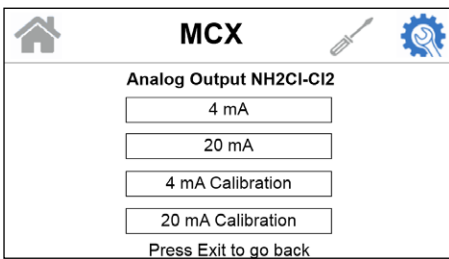

5. Use the ▲ and ▼ arrows to enter the desired setting and then press ↵ to save.

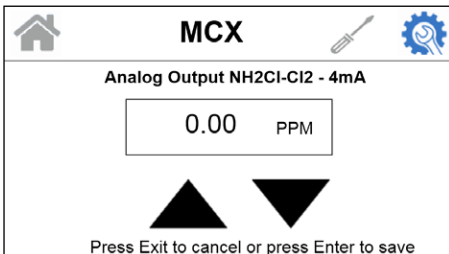

6. Once all outputs have been saved, press the **EXIT** button until the instrument returns to the home screen.

Setting the Units of Measurement

This instrument can measure in Parts per Million (ppm) and Milligrams per Liter (mg/L). To select the unit of measurement:

1. Select **Units** from the Configuration Menu and press ↵.
2. Using the ▲ and ▼ arrows, select the desired unit of measurement.

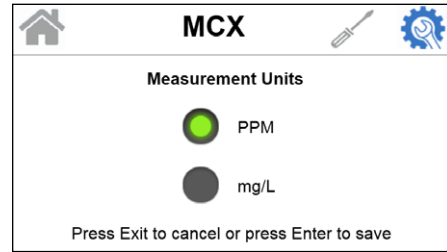

3. Press ↵ to save.
4. Once the units of measurement have been saved, press the EXIT button to return to the home screen.

Setting the Date/Time

The time and date can be adjusted using this menu. The change will be reflected in the date/time stamps on the home screen and logged data. To set/change the date/time:

1. Select **Date/Time** from the Configuration Menu and press ↵.
2. Using the ▲ and ▼ arrows, select **Set Date** or **Set Time** and press ↵.

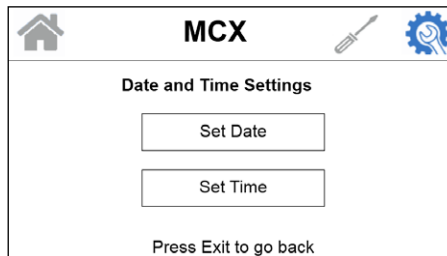

3. If changing the date, use the ◀ and ▶ arrows to select the month, date or 2-digit year and the ▲ and ▼ to change the date. The time is adjusted in a similar manner. Press ↵ to save.
4. Press the EXIT button to return to the home screen.

Adjusting the Brightness

The screen brightness can be adjusted to provide easier readability of the display in low light or no light conditions. There are 10 brightness levels available. To adjust the screen brightness:

1. Select **Brightness** from the Configuration Menu and press ↵.
2. Using the ▲ and ▼ arrows, select the desired brightness and press ↵.

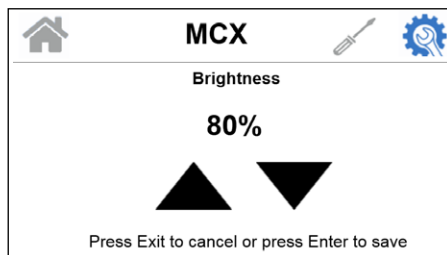

3. Press the EXIT button to return to the home screen.

Screen Saver Timeout

The amount of time that passes before the screen saver turns on can be adjusted. The default is 2 minutes. The minimum time for the screen saver is 0 minutes. The maximum time is 10 minutes. To adjust the screen saver time out:

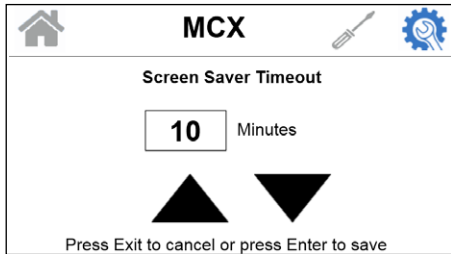

1. Select **Screen Saver Timeout** from the Configuration Menu and press **↵**.
2. Using the **▲** and **▼** arrows, select the minutes and press **↵**.
3. Press the EXIT button to return to the home screen.

Setting the Time Between Measurements

The amount of time in hours and minutes can be adjusted using this menu. The default time is 0 hour, 0 minutes. The minimum time between readings is 0 hours, 0 minutes. The maximum time between readings is 24 hours. If the instrument is in Auto Mode, a countdown of the time until the next measurement will be taken is shown on the bottom of the home screen in the status banner. For more information on Reading Modes, see “Setting the Reading Mode” section. To set the time between readings:

1. Select **Time Between Readings** from the Configuration Menu and press **↵**.

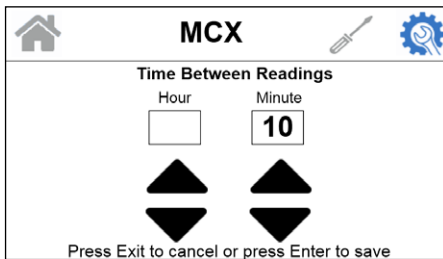

2. Using the **▲** and **▼** arrows, select the hours and minutes and press **↵**.
3. Press the EXIT button to return to the home screen.

Setting the Reading Mode

The MCX has 2 different modes of taking readings. The first is Auto Mode. In Auto Mode, measurements are taken at a preset time interval and displayed on the Home screen. A countdown clock showing the time until the next reading is displayed in the status bar on the bottom of the home screen.

The second mode is Grab Sample. In Grab Sample, the date/time button on the home screen is used to take an on-demand reading. The date/time button displays the date and time of the last reading while the measurement data is shown to the right. The status bar shows GOOD, rather than a countdown clock.

To set the Reading Mode:

1. Select **Measurement Option** from the Configuration Menu and press **↵**.
2. Use the **◀** and **▶** arrows to select **Auto** or **Grab Sample**.
3. Use the **▲** and **▼** arrows to select a parameter to monitor: NH₂Cl-Cl₂, NH₃-N or Both. Press **↵** to save.

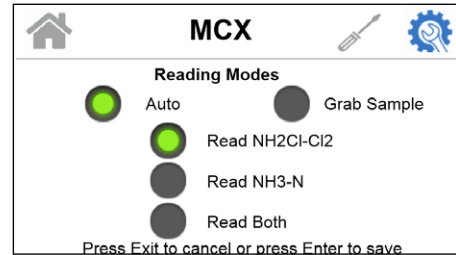

4. Press the EXIT button to return to the home screen.

NOTICE

To get an accurate free ammonia reading, you must take a total ammonia and monochloramine measurement.

Adjusting the Line Flush Duration

A line flush is necessary to wash the cuvette between measurements. The line flush setting is used to set the amount of time in seconds to wash the cuvette. This time will be applied to the wash step in the reading sequence, discussed later in this manual. The default duration is 5 seconds, which is also the minimum. The maximum line flush duration is 60 seconds. **The suggested line flush duration is 1 second for every foot of sample line tubing.**

To adjust the line flush duration:

1. Select **Line Flush Setting** from the Configuration Menu and press **↵**.
2. Use the **▲** and **▼** to set the desired duration for the line flush in seconds and press **↵**.

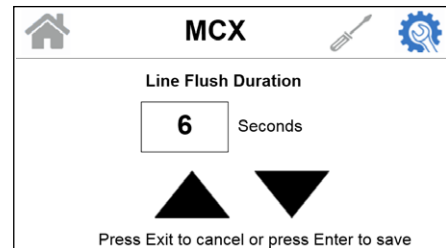

3. Press the EXIT button to return to the home screen.

Modbus Address

The modbus slave address can be adjusted to the user's needs. See Modbus configuration section later in this manual for information. To adjust the modbus slave address:

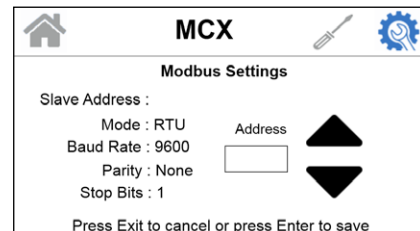

1. Select **Modbus** from the Configuration Menu and press **↵**.
2. Using the **▲** and **▼** arrows, select the modbus slave address and press **↵**.
3. Press the EXIT button to return to the home screen.

Diagnostics

This menu is used for troubleshooting components of the instrument. The following functions activate the components so that the user can visually inspect the instrument. To access Fill, Drain or Water Detect LED the instrument must be put into grab sample mode. Environment can be accessed during normal operation.

- Fill - allows the user to fill the sample cuvette, testing the peristaltic pump.
- Drain - allows the user to test the drain solenoid. This operation will drain the cuvette.
- Measure LED - allows the user to test the function of the red measurement LED by turning on the LED.
- Water detects LED - allows the user to test the function of the red water LED by turning on the LED.
- Environment - displays the environmental parameters. This includes temperature, humidity, reaction chamber temperature and heater thermocouple temperature.

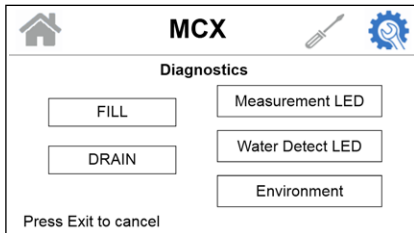

Security Setting

The MCX has a security setting that when enabled will only allow authorized users with a valid numeric password to configure the instrument. The user must enter a 6 digit PIN to gain admin access. There is a Master PIN that is hard-coded into the software and it cannot be changed. If a user forgets their personal pin, HF can provide the Master PIN and the instrument will prompt the user to choose a new PIN. Contact HF scientific Technical Service Department for the Master PIN.

To enable a Security PIN:

1. Select **Security** from the Configuration Menu and press **↩**.
2. Using the **▲** and **▼** arrows, enter the security pin. If this is the first time entering the Security PIN, enter the Master PIN "555555". If you already have a personal PIN assigned, enter that PIN. Press **↩**.

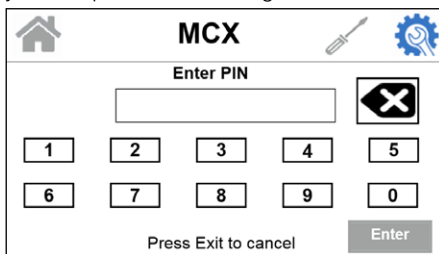

3. Using the **▲** and **▼** arrows, select **Enable Admin** or **Change PIN** and press **↩**.

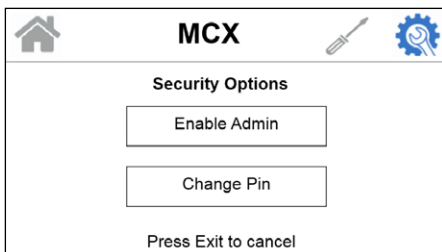

4. If selecting to **Enable Admin**, enter the security PIN again to enable. If selecting **Change PIN**, enter the new pin. You will be prompted to enter the new pin a second time. Then press **↩**.
5. Once the security PIN or setting has been saved, press the EXIT button to return to the home screen.

Clear Errors and Warnings

This menu will allow the operator to clear errors on the instrument. Errors and warnings will be displayed on the home screen banner. This operation clears all active errors and warnings and restarts the instrument. To clear any errors or warnings showing on the MCX:

1. Select **Clear Errors/Warnings** from the Configuration Menu and press **↩**.

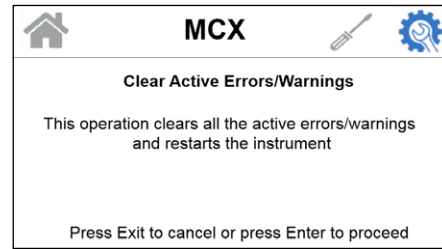

2. The screen will display text letting the user know that this operation clears all active errors and warnings and restarts the instrument. To proceed, press **↩** or press EXIT to cancel and return to the home screen.

Firmware Update

Software for the MCX can be updated using a micro USB stick. While the software is being updated, it is important to not turn off power to the instrument. Once the software update has been complete, the instrument will require a reboot. To ensure the software update was successful, you can view the software version in the About Device menu.

To update the software on the MCX:

NOTICE

1. Select **Firmware** from the Configuration Menu and press **↩**.
2. Insert a micro USB stick containing the software update into the micro USB slot on the display board located on the electrical panel door.



SD Card Slot on the Display Board

Display Board Located on the Electrical Panel Door

NOTICE

Do not remove the micro USB stick or turn power off while the software update is in progress. Doing so can cause an unrecoverable failure.

3. Using the ◀ and ▶ arrows, select **Accept** and press ↵.

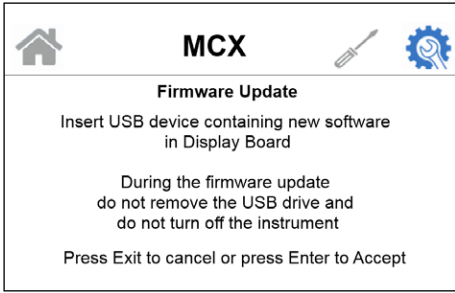

4. Using the ▲ and ▼ arrows, select **Update Main Display** or **Update Main UI** or **Update Main Measurement** and press ↵.

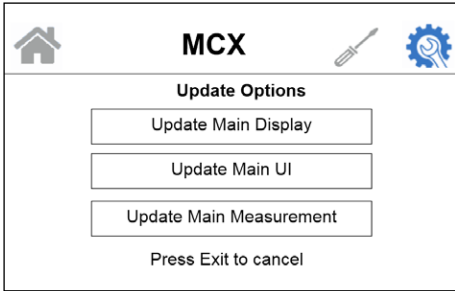

5. After pressing the update option, the firmware will begin to update. A status update will appear on the screen to display the progress of the update. Once the update is complete, the MCX will restart automatically.

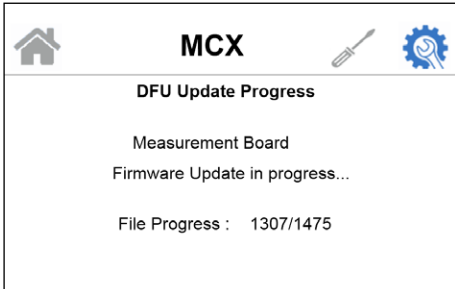

Copying FRAM data to Micro-USB

The following information from the MCX can be transferred to a micro-USB in CSV file format.

- Readings
- Error and warning logs with date and time stamps

To transfer data from the MCX to a micro-USB:

1. Select **Copy FRAM Data to Micro-USB** from the Configuration Menu and press ↵.
2. Insert a micro-USB into the micro-USB slot on the display board located on the inside of the door of the electrical panel and press ↵ to start the download.

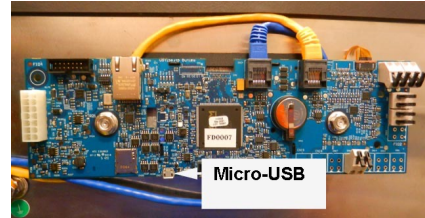

3. A status update will appear on the screen stating Copying Records to USB in Progress.

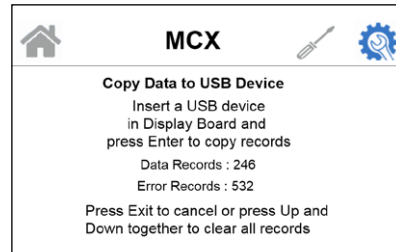

4. Once the data has been copied to the micro-USB, a completion update will appear on the screen. The micro-USB can now be removed.

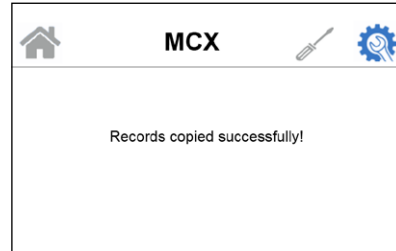

Instrument ID

The instrument ID can be changed to any 4 digit number. The default instrument ID is 0000. To change the instrument ID:

1. Select **Instrument ID** from the Configuration Menu and press ↵.
2. Using the ▲ and ▼ arrows, enter the desired Instrument ID and press ↵.

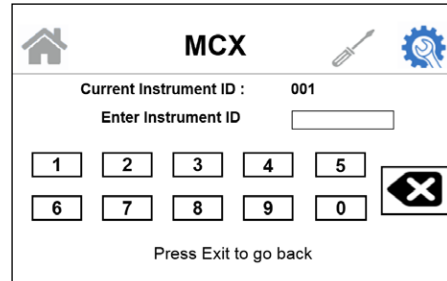

3. Press the EXIT button to return to the home screen.

Data Resolution

The data resolution is shown in decimal places. The number of decimal places can be changed. The default is 2 decimal places. To change the number of decimal places:

1. Select **Data Resolution** from the Configuration Menu and press **↵**.
2. Using the **▲** and **▼** arrows, enter the desired decimal places and press **↵**.

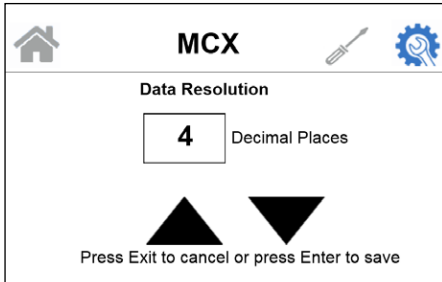

3. Press the EXIT button to return to the home screen.

Factory Reset

To reset all settings to factory defaults:

1. Select **Factory Reset** from the Configuration Menu and press **↵**.
2. Press **↵** if you wish you to proceed with the factory reset. This cannot be undone.

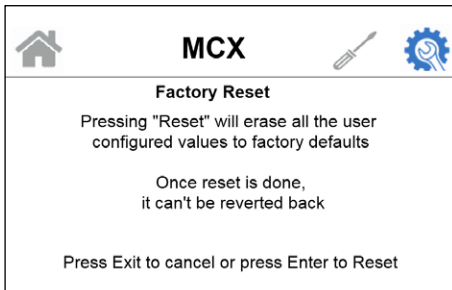

3. A status message will appear letting you know all configurable parameters have been reset to factory defaults and MCX will restart automatically.
4. The last calibration is not affected and will not require a new calibration.
5. The analog outputs will need to be re-spanded and trimmed once the factory reset is done.

About Device

The About Device menu displays information about the MCX.

To view any of this information:

1. Select **About Device** from the Configuration Menu and press **↵**. The software version, software build date and hardware version will be displayed.

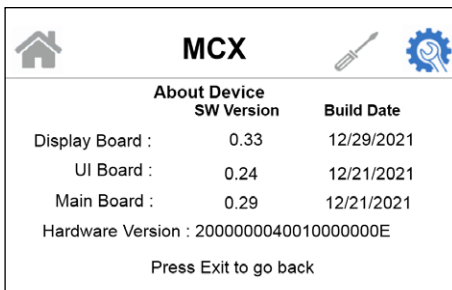

2. Press **EXIT** to return to the previous menu.

Offsets

Offset values are added to the final calculated readings before displaying them and inserting them in the Data Logs. The default is 0. The minimum is -0.25 and the maximum is +0.25.

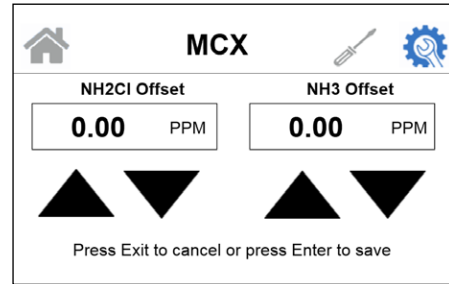

Alarms

MCX offers two programmable relays that can generate alarms in the event of an Error/Warnings/End of Cycle. The default for Alarm 1 is Errors. The default for Alarm 2 is Warnings.

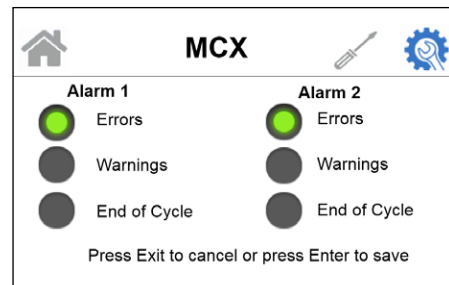

Signal Averaging

The default signal averaging setting is 1. To change the averaging points:

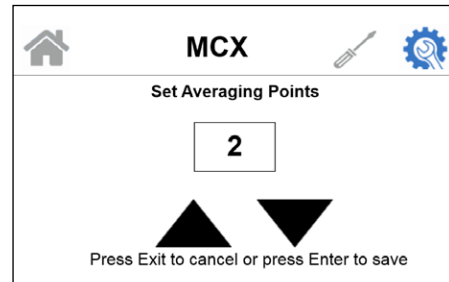

1. Select **Signal Averaging** from the Configuration Menu and press **↵**.
2. Using the **▲** and **▼** arrows, enter the desired averaging points and press **↵**.
3. Press the EXIT button to return to the home screen.

System Start Up

Once all plumbing connections and configurations have been made, the MCX is ready for use.

Prepare Reagents

The reagent bottles have a colored dot on them that corresponds with the line it connects to on the MCX.

- Red - Chlorination Solution
- Yellow - Indicator Solution
- Blue - Buffer Solution



To connect the reagents to the MCX:

1. Enter service mode by pressing the MODE button then press **↵** to stop the analysis and enter the service menu.
2. Remove the old reagent bottles (if necessary) from the analyzer.

3. Fill the provided syringe with DI water and slowly push a full syringe of DI water from the bottom of the reagent tubing through the system (see photo). Watch the DI water come into the cuvette during this step by removing the light shield from the front of the cuvette. Do this for each reagent tubing assembly.



4. Wait 5 minutes and complete step 3 again, making sure to leave the lines full of DI water for the prime cycle.
5. Uncap the new reagent bottles and remove the heat seal. Install new reagent bottles, matching the colored dot on the bottle to the color of connections on the tubing (blue dot with blue connector, yellow dot with yellow connector, etc).
6. Press **↵** to select the PRIME option on the service menu.
7. Select PRIME BUFFER from the priming options. Press **↵** and allow the entire buffer prime sequence to run (about 90 seconds). Watch the liquid level in the cuvette to ensure liquid is being pumped through the system.
8. Select PRIME INDICATOR from the priming options. Press **↵** and allow the entire indicator prime sequence to run (about 90 seconds). Watch the liquid level in the cuvette to ensure liquid is being pumped through the system.
9. Select PRIME CHLORINATING SOLUTION from the priming options. Press **↵** and allow the entire chlorinating solution prime sequence to run (about 90 seconds). Watch the liquid level in the cuvette to ensure liquid is being pumped through the system.
10. When finished priming and replacing all reagents press the EXIT button once, then press the **▼** arrow twice, then **↵** to select REAGENT STATUS. Once in the REAGENT STATUS screen, press **↵** to reset the reagent counter. Acknowledge prompt that the counter will reset by pressing **↵** once.
11. Press the EXIT button and allow the analyzer to resume normal operation.

If you have any questions, call your local sales representative or HF Scientific at 1-888-203-7248 and select option 2 for sales.

Priming the MCX

Once the reagent bottles have been properly connected, the MCX needs to be primed before taking readings.

To prime the MCX:

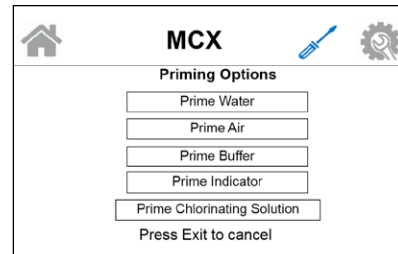

1. Press enter to select the “Prime” option on the service menu.
2. Select prime buffer from the priming options. Press enter and allow the entire buffer prime sequence to run (About 90 seconds). Watch the liquid level in the cuvette to ensure liquid is being pumped through the system.
3. Select prime indicator from the priming options. Press enter and allow the entire indicator prime sequence to run (About 90 seconds). Watch the liquid level in the cuvette to ensure liquid is being pumped through the system.
4. Select prime chlorinating solution from the priming options. Press enter and allow the entire chlorinating solution prime sequence to run (About 90 seconds). Watch the liquid level in the cuvette to ensure liquid is being pumped through the system.
5. Hit the exit button and allow the analyzer to resume normal operation.

Taking Readings

Once priming has been completed successfully, the MCX is ready to take readings. MCX will take readings manually or automatically at preset intervals, depending on the setting. See Setting the Reading Mode section for more information.

NOTICE

There is a removable light shield attached to the optical block to help prevent light from entering the optical block and affecting the readings. Be sure this shield is in place at all times when taking readings or doing a calibration to ensure reading accuracy.

Modbus Configuration

Coils

These single-bit values are readable and changeable from the master. The data will be returned with the lowest addressed coil in the LSB of the data. Unused data bits will be set to 0. True is a 1 and false is a 0.

Valid Command(s)

Code	Name	Broadcast?
0x01	Read Coil Status	No
0x05	Force Single Coil	Yes

Format

16-bit word format

Valid Addresses

00001 - 00XXX

Definitions

Address	Function	Default
00001	Prime Water	False
00002	Prime Air	False
00003	Prime Buffer	False
00004	Prime Indicator	False
00005	Prime Chlorinating Solution	False
00006	Service Mode	False

Input Status

These single-bit values are readable from the master. The data will be returned with the lowest addressed input status in the LSB of the data. Unused bits in the data will be set to 0. True is a 1 and False is a 0.

Valid Commands

Code	Name	Broadcast?
0x02	Read Input Status	No

Format

16-bit word format

Valid Addresses

10001 - 10XXX

Definitions

Address	Function	Default
10001	Instrument Error	False

Input Registers

These 16-bit values are readable by the master. The data is stored with the MSB first and then the LSB.

Valid Commands

Code	Name	Broadcast?
0x04	Read Input Registers	No

Format

Float - stored in two consecutive addresses, with the first address containing the least significant word (lower part of mantissa) and the second address containing the most significant word (sign, exponent, and upper part of mantissa).

Valid Addresses

30001 - 30XXX

Definitions

Address	Type	Register	Function
30001 - 30002	Float	NH2CL-CL2 Sensor reading	The NH2CL-CL2 meter reading displayed
30003 - 30004	Float	NH2CL-CL2 Sensor reading raw	NH2CL-CL2 Sensor reading to six significant places
30005 - 30006	Float	NH2CL-CL2 Sensor reading without cuvette correction	
30007 - 30008	Float	Total NH3-N Sensor reading	The Total NH3-N meter reading displayed
30009 - 30010	Float	Total NH3-N Sensor reading raw	Total NH3-N Sensor reading to six significant places
30011 - 30012	Float	Total NH3-N Sensor reading without cuvette correction	
30013 - 30014	Float	Free NH3-N Sensor reading	The Free NH3-N meter reading displayed
30015 - 30016	Float	Free NH3-N Sensor reading raw	Free NH3-N Sensor reading to six significant places
30017 - 30018	Float	Free NH3-N Sensor reading without cuvette correction	
30019 - 30020	Float	Firmware version MMB	Main Measurement Board Firmware Version
30021 - 30022	Float	Firmware version UIB	User Interface Board Firmware Version
30023 - 30024	Float	Firmware version DB	Display Board Firmware Version

Holding Registers

These 16-bit values are readable and changeable from the master. The data is stored with the MSB first and then the LSB.

Valid Commands

Code	Name	Broadcast?
0x03	Read Holding Registers	No
0x06	Preset Single Register	Yes
0x16	Preset Multiple Register	Yes

Format

Float - stored in two consecutive addresses, with the first address containing the least significant word (lower part of mantissa) and the second address containing the most significant word (sign, exponent, and upper part of mantissa).

Valid Addresses

40001 - 40XXX

Definitions

Address	Type	Register	Min	Default	Max	Function
40001	Int	Decimal Places (when ppb units are selected, only 1 decimal place is possible)	0	2	4	0 - XXXXX 1 - XXXX.X 2 - XXX.XX 3 - XX.XXX
40002	Int	Units (scaling)	0	0	1	0 - PPM 1 - PPB
40014	Int	Instrument Address	1	1	255	
40015	Int	Time between measurements	0	60	1440	Wait time between readings in minutes

Exception Responses Implemented

Code	Name	Meaning
00	--	No error
01	ILLEGAL FUNCTION	The function code is not allowed in the device.
02	ILLEGAL DATA ADDRESS	The data address is not allowed in the device
03	ILLEGAL DATA VALUE	A value contained in the query field is wrong for the device

Maintenance

Calibration

The MCX was tested and calibrated prior to leaving the factory. The instrument operates from a predetermined calibration curve for high accuracy. Calibration solutions are available from many different chemical distributors.

When performing calibration, a calibration kit is necessary. The calibration kit includes:

- DI Water Rinsing Solution (250 ml) (**Solution A** in Cal Procedure)
- 2ppm NH₃-N(250 ml) (**Solution B** in Cal Procedure)

NOTICE

The standards are to be used on the day that they are opened. Ammonia standards are very volatile, meaning the value of the standard will drop over time.

To recalibrate the MCX, follow the prompts on the screen.

1. Select **Service Mode** from the Configuration Menu and press **↵**.
2. Using the **▲** and **▼** buttons, navigate to **User Calibration** and press **↵** to initiate.

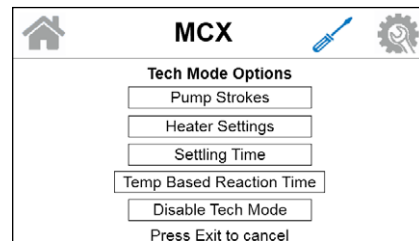

3. Using the **▲** and **▼** buttons, select the Standard to calibrate. Press **↵**.

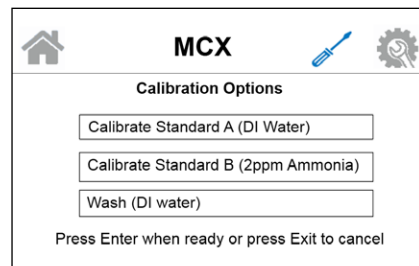

4. Turn off the water supply. Press **↵**.

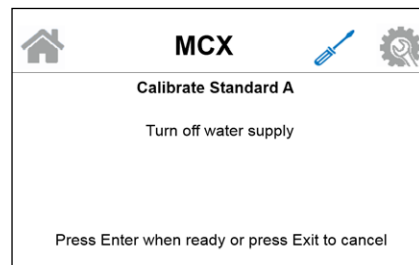

5. Insert grab sample intake tube in Standard A (DI Water) solution bottle. Press **↵**.

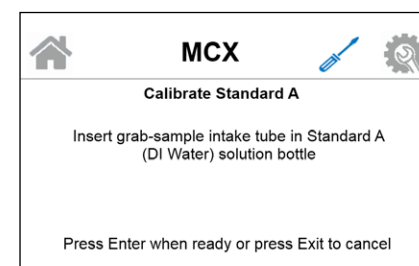

6. During this time, the software will take 1 low end reading and store the reading as calibration data. An acceptable data point range is >0.0 and less than 0.02. When the reading is captured, press **↵**.

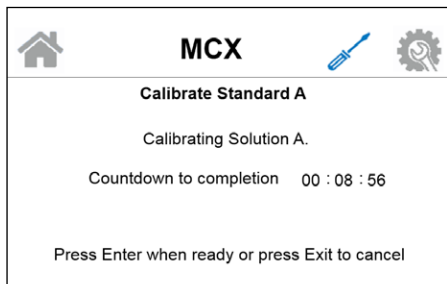

7. Calibration of Standard A is now complete. Calibration data is saved after all steps of calibration of Standard A are complete. If calibration is canceled at any point during Standard A calibration process, the last successful calibration data remains stored. Press **↵** to accept the results or press cancel to not accept.

8. The MCX will then show the Calibration Options screen. Using the **▲** and **▼** buttons, select Calibrate Standard B and press **↵**.

9. Remove tube from Solution A bottle. Insert tube into Solution B bottle (2ppm Ammonia). Press **↵**.

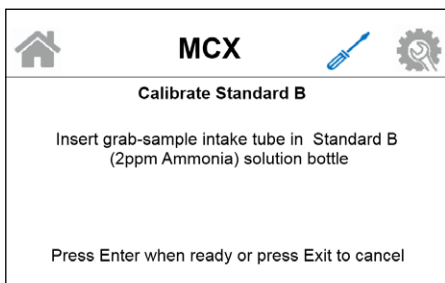

10. The instrument will take 1 high end reading and store the reading as calibration data. An acceptable data point range is between 1.15 to 1.40. When the reading is captured, press **↵**.

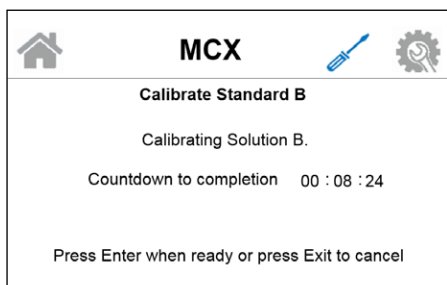

11. Calibration of Standard B is now complete. Calibration data is saved after all steps of calibration of Standard B are complete. If calibration is canceled at any point during Standard B calibration process, the last successful calibration data remains stored. Press **↵** to accept the results or press cancel to not accept.

12. The MCX will then show the Calibration Options screen. Using the **▲** and **▼** buttons, select Wash (DI Water) and press **↵**.

13. Remove tube from Solution B bottle. Insert tube into DI Water bottle. Press **↵**.

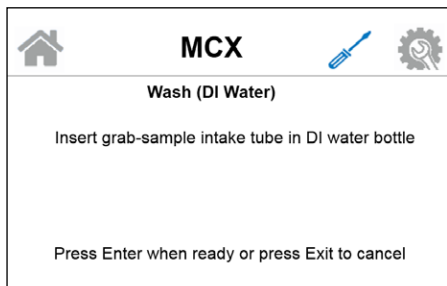

14. The instrument will do a wash with DI water. When the DI wash is complete, the instrument will go back to the Calibration Options screen.

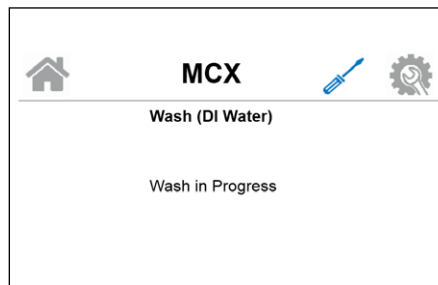

15. Remove the calibration tube from the instrument and reattach the water supply tubing. The calibration is now complete. Press **↵** twice to return to normal operation.

Verification/External Grab Sample

To install the grab sample tubing:

1. Turn off water supply to the instrument.
2. Install shut-off valve on the inlet supply line.
3. Cut tubing to desired lengths necessary for each specific installation.
4. Run a piece of tubing from the shut-off valve to the tee, then continuing in-line, add another piece of tubing from the tee to another shut-off valve. From the shut-off valve, run a piece of tubing to the grab sample. Then add another piece of tubing coming out of the tee to the instrument.
5. To run from the sample line, open the inlet shut-off valve and close the second shut-off valve. To draw from a sample, close the inlet shut-off valve and open the second shut-off valve.

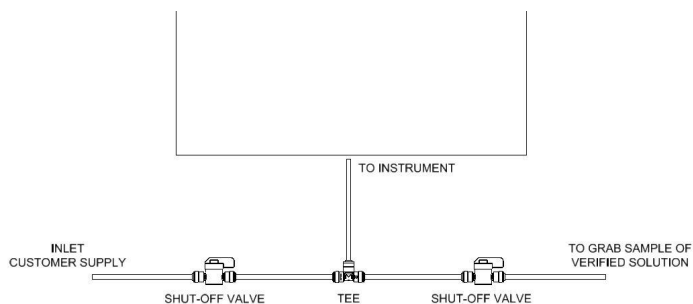

Maintenance

Cuvette Cleaning

To clean or replace the cuvette on MCX:

1. Put the instrument into service mode. This will drain the cuvette.
2. Loosen the knurled nut at the top of the optics assembly
3. Carefully remove the cuvette to clean.
4. After cleaning or replacing, ensure that the knurled top is hand tight. When water is first applied check for leaks.

Heater Scale Removal Procedure - Use the Grab Sample Accessories

1. Put the instrument into Service Mode.
2. Disconnect the drain tube and install a new tube that will be recirculated to common container.
3. If using the grab sample accessory (28178S), take the grab sample line and insert it into the common container. Otherwise use a new length of tubing to connect to the sample inlet fitting and insert it into the container.
4. Fill the container with a calcium, lime and rust remover.
5. In the Service menu select Prime then Select Prime Water to begin flushing the heater with the cleaning solution. Allow the solution to recirculate until you stop seeing bubbles in the container. If bubbles are still seen in the solution when the prime function completes, select Prime Water again.
6. Once complete, reconnect the drain tubing and the sample water inlet. If using the grab sample kit close the grab sample valve and open the sample supply valve. In the service menu select Prime water and allow the function to run to completion before putting the instrument back into auto mode.

Replacing the Complete Tubing Kit

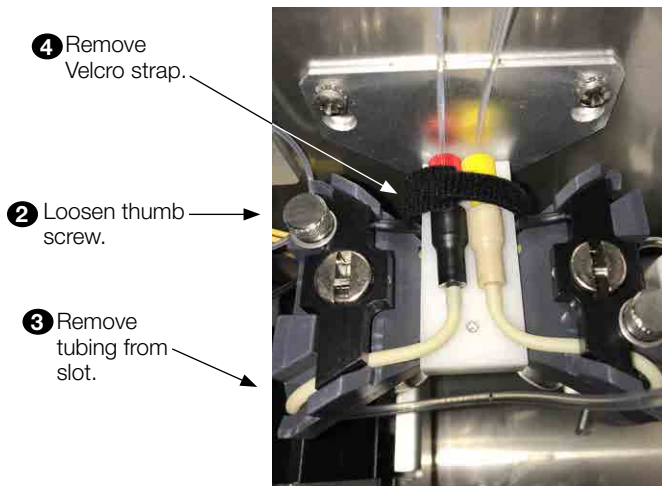

⚠ WARNING

To avoid the risk of electrical shock, ensure power to the instrument has been disconnected prior to beginning replacement of the annual tubing kit.

(#28182S)

1. Turn off water supply to the MCX instrument.
2. Unscrew cap from reagent bottle and set solution aside.
3. Remove the Velcro strap holding reagent tubing in place on top of pump bracket, set aside.

4. Unscrew the thumbscrew on the reagent pump and set thumbscrew and washer aside.



5. Lift the black pump hammer up to allow access, remove tubing from slot on outside of reagent pump then remove the pump balancing loop from the rear of the pump. The balancing loop is the section of the tubing used to balance the pump hammer located to the rear of the pump.

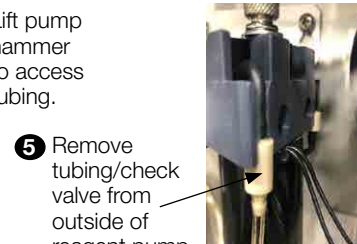

6. Using a screw driver, loosen the screw on the optical assembly that holds the reagent injectors in place.

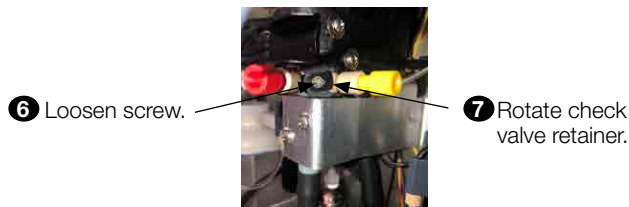

7. Rotate the check valve retainer 90° and disconnect the injector from the optical assembly.
8. Ensure duckbill was attached to injector upon removal. If not, remove duckbill from connection on optical assembly.
9. Place new injector with duck bill attached into the optical assembly.
10. Rotate the check valve retainer 90° and tighten screw to lock injector in place in the optical assembly



Duckbill (on injector side of tubing only)

11. Guide tubing back into slot on outside of reagent pump, then place the pump balancing loop into slot toward rear of pump.
12. Lower the black pump hammer back into place, then reinstall thumbscrew and washer on the reagent pump.
13. Re-use the Velcro strap to secure the reagent tubing check valves to the top of the pump bracket.
14. Fill the flush kit syringe with DI water and slowly push a full syringe of DI water from the bottom of the reagent tubing through the system. Watch the DI water come into the cuvette during this step by removing the light shield from the front of the cuvette. Do this for each reagent tubing assembly. Make sure to leave the lines full of DI water for the prime cycle.
15. Reattach new caps onto the reagent bottles.
16. Enter service mode by pressing the MODE button then press **←** to stop the analysis and enter the service menu.
17. Press **←** to select the PRIME option on the service menu.
18. Select each reagent for which the cap assemblies were changed.

Replacing the Reagent Pump (Kit #28181S)

⚠ WARNING

To avoid the risk of electrical shock, ensure power to the instrument has been disconnected prior to beginning replacement of the annual tubing kit.

To replace the reagent pump on the MCX instrument:

1. Loosen the 2 screws that hold the reagent pump bracket to the back panel.

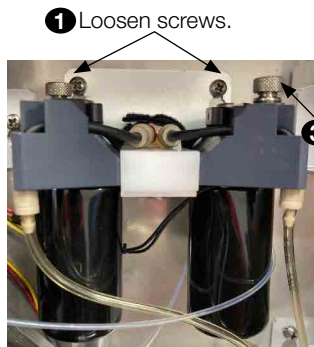

① Loosen screws.

③ Remove thumb screw and washer, raise hammer to remove reagent tubing and pump balancing loop.

2. Lift the bracket assembly off of the screws.
3. Remove thumb screw and washer raise pump hammer to allow reagent tubing and pump balancing loop to be removed from under pump hammer.
4. Unplug the wire connection from the reagent pump. Note that the color of the wire in which the pump is connected to is associated to the color of the plastic fitting and the chemical solution that is used with that pump.
5. Unscrew the 2 allen screws holding the reagent pump to the mounting block.

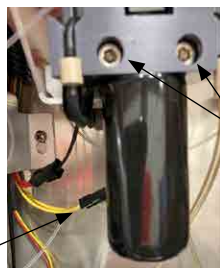

⑤ Unscrew allen screws.

④ Unplug wire connection.

6. Install new reagent pump to the mounting block using the 2 screws removed in Step 5.
7. Plug wire connections into new reagent pump.
8. Place reagent tubing and pump balancing loop under pump hammer, making sure to place the check valve and connector into their respective grooves. Then reinstall the washer and thumb screw.
9. Screw the reagent pump bracket to the back panel using the 2 screws that were loosened in Step 1.
10. Turn instrument on.

Replacing the Peristaltic Pump Head (Kit #28141S)

To replace the peristaltic pump on the MCX instrument:

1. Push tabs in on sides and pull up to remove the pump head from the base.
2. Remove existing clamps and detach hoses. Take care to keep hose ends in good condition and note which hose is connected to the IN and which is connected to the OUT; these will need to be reattached to the new pump head in the same order.

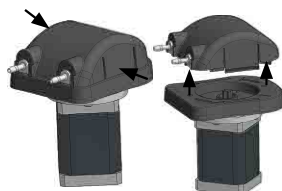

3. Based on the arrows between the pump head fittings, reattach the IN hose to the IN pump head fitting and the OUT hose to the OUT pump head fitting. Secure using the new clamps.

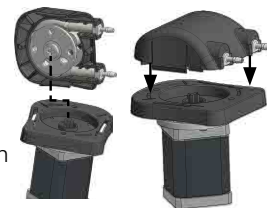

4. Align the cutout of the pressure rotor with the cutout in the base.
5. Lower the new pump head down to securely reattach it to the base.

Replacing the Pressure Regulator Assembly (Kit #28158S)

To replace the pressure regulator assembly on the MCX instrument:

1. Turn off water to the instrument.
2. Loosen the screws on the bracket connecting the pressure regulator to the back panel.
3. Lift bracket and attached components from back panel.
4. Loosen the water inlet tube (orange) from the pressure regulator.

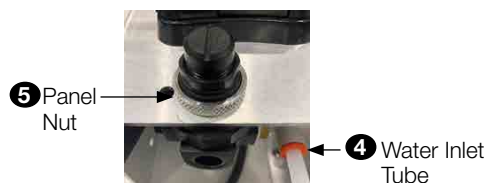

⑤ Panel Nut

④ Water Inlet Tube

5. Remove the panel nut that holds the regulator in place.
6. Lower the regulator down through the bracket.
7. Remove fittings (x2) from inlet and outlet of regulator. Be sure to note "IN" and "OUT" positions of the regulator.



⑦ Remove Outlet Fitting and Clean

⑦ Remove Inlet Fitting and Clean

8. Clean off the old fittings and apply new PTFE tape to the threads of the fittings.
9. Reinstall the fittings into the new regulator in the same orientation as the original. Be sure the "IN" and "OUT" positions are orientated the same as the old regulator. "IN" and "OUT" are labeled on the pressure regulator.



⑨ Outlet Label (Black Fitting, Black Tubing)

⑨ Inlet Label (White Fitting, Orange Connector, Clear Tubing)

10. Place the regulator back into the brackets and secure into place with panel nut.
11. Reattach bracket and attached components to the back panel and tighten screws loosened in step 2.
12. Insert the water tubing back into the push to connect inlet fitting.
13. Turn water supply to MCX instrument back on.
14. Turn MCX instrument on and check for leaks.

Replacing the Air Pump (Kit #28164S)

To replace the air pump on the MCX instrument:

⚠ WARNING

To avoid the risk of electrical shock, ensure power to the instrument has been disconnected prior to beginning replacement of the air pump kit.

1. Disconnect the vent tube from the side of the cabinet.

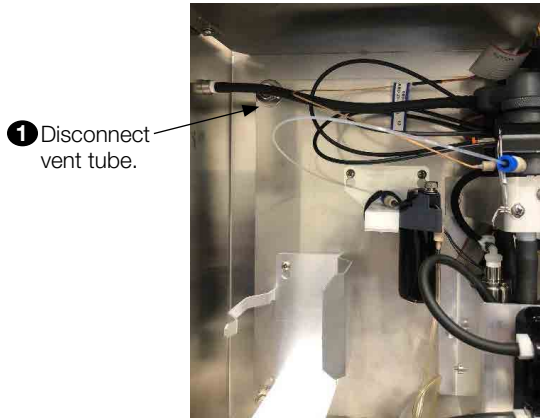

2. Disconnect the ribbon cable from the optical board.

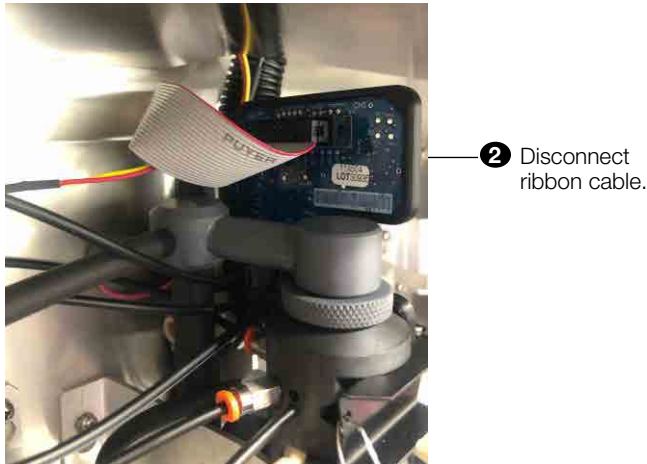

3. Loosen the press to connect fitting and disconnect the drain tubing at the bottom of the enclosure.

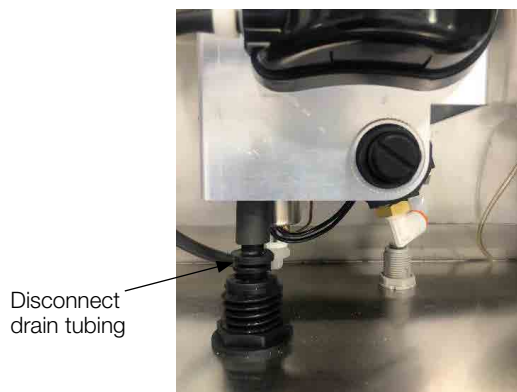

4. Loosen the optical block assembly bracket screws. This is the bracket that holds the optical block assembly to the back panel.
5. Lift optical block assembly up and off of bracket screws.
6. Pull optical block assembly forward to access the air pump. The air pump is located on the back right hand side.

7. Disconnect the black and pink air pump wiring (connection located in the electrical panel, wires routed in corrugated sleeving).

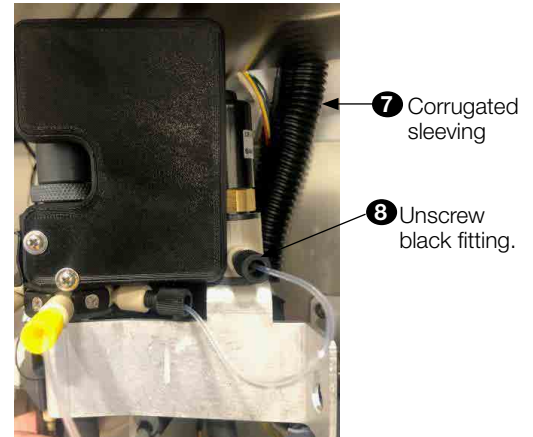

8. Unscrew black fitting from air pump.
9. Unscrew 2 screws from underneath air pump bracket and remove the air pump.
10. Insert new air pump. Be sure the arrow on the new air pump is facing the correct direction.
11. Install 2 screws from underneath air pump bracket.
12. Screw in black fitting into air pump outlet.
13. Reconnect the black and pink air pump wiring (connection located in the electrical panel).
14. Slide the optical assembly with new air pump back to original position.
15. Place optical block assembly onto bracket screws located on the back panel of the enclosure.
16. Tighten the optical block assembly bracket screws.
17. Reconnect the drain tubing, ribbon cable and vent tube.

NOTICE

To prevent damage to the wiring, ensure wiring is routed behind bracket and not pinched between the bracket and the back panel of the enclosure.

Replacing the Cap and Inlet Tubing (Kit #28179S)

To replace the cap and inlet tubing on the MCX instrument:

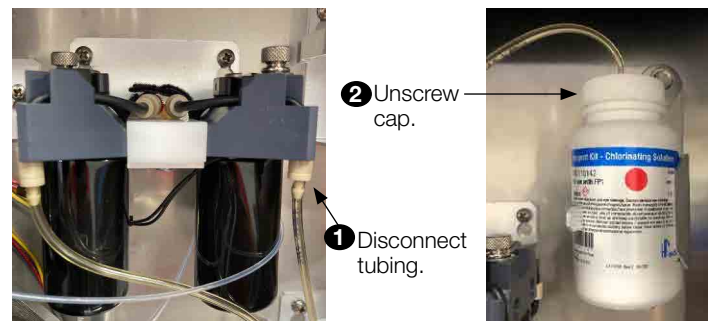

1. Disconnect tubing from reagent pump inlet check valve.
2. Unscrew cap from reagent bottle.
3. Connect tubing from the new cap assembly back onto the reagent pump inlet check valve.
4. Fill the flush kit syringe with DI water and slowly push a full syringe of DI water from the bottom of the reagent tubing through the system. Watch the DI water come into the cuvette during this step by removing the light shield from the front of the cuvette. Do this for each reagent tubing assembly. Make sure to leave the lines full of DI water for the prime cycle.

5. Reattach new caps onto the reagent bottles.
6. Enter service mode by pressing the MODE button then press **←** to stop the analysis and enter the service menu.
7. Press **↵** to select the PRIME option on the service menu.
8. Select each reagent for which the cap assemblies were changed.

NOTICE

After replacing the cap and inlet tubing, the MCX requires to be flushed and primed. See Priming section earlier in this manual for instructions.

Replacing the Thermocouple (Kit #28180S)

To replace the thermocouple on the MCX instrument:

WARNING

To avoid the risk of electrical shock, ensure power to the instrument has been disconnected prior to beginning replacement of the thermocouple.

1. Turn off water to the MCX instrument.
2. Unplug the connector containing the thermocouple wires (red & yellow) that go to the optical board. Take note of the proper orientation/placement of this connector.



- 2 Remove plug from optical board then remove red and yellow wires from plug.
- 3

3. Remove the red & yellow wires from connector. Take note of the proper orientation/placement of these wires.
4. Using a screwdriver, loosen the screw holding the retainer on the optical assembly that holds the thermocouple in place, rotate the retainer 90°.



- 4 Loosen screw holding retainer and rotate 90° to remove thermocouple



- 6 O-ring

5. Remove thermocouple from optical block, making sure that the o-ring is attached. If not, remove o-ring from the optical block.
6. Place new thermocouple into the optical block making sure that the o-ring is installed onto the end of it.
7. Rotate the retainer 90° and tighten screw to lock thermocouple into place.
8. Reconnect the red & yellow thermocouple wires to the connector, then plug back into the optical board, making sure of proper orientation/placement of the connector and wires.
9. Turn water supply to the MCX instrument back on.
10. Turn MCX instrument on and check for leaks.

Replacing the Heater (Kit #28172S)

To replace the heater in the MCX instrument:

WARNING

To avoid the risk of electrical shock, ensure power to the instrument has been disconnected prior to beginning replacement of the heater.

1. Turn off water to the MCX instrument.

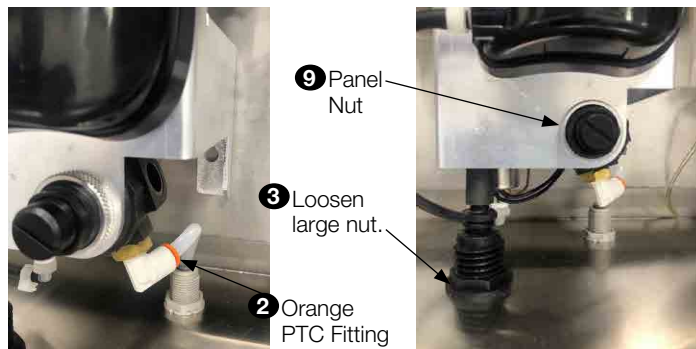

2. Disconnect the water inlet tube (orange) from the pressure regulator.
3. Loosen large nut completely from inside of the enclosure holding drain line in place, then remove drain from bottom of enclosure by releasing the push-to-connect fitting.
4. Disconnect thermocouple plug and the two black heater power wires that are located on the main measurement board in the electronics compartment. These wires will need to be removed from the inside of the corrugated sleeving. Make note of plug & wire location and orientation.

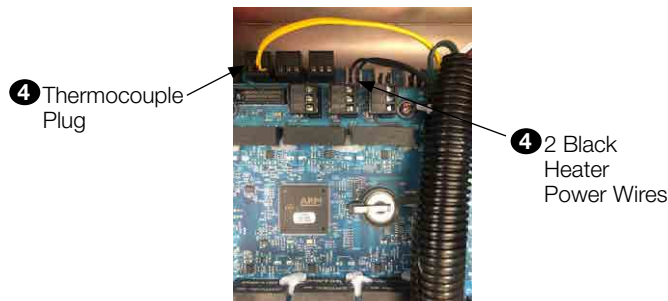

5. Remove the red & yellow wires from connector. Take note of the proper orientation/placement of these wires in the connector. See Main UI Board image in Low Voltage Connections section of this manual for wire locations.
6. Loosen the screws to the bracket that holds the intake assembly to the back panel.
7. Lift intake assembly up and off of mounting screws, turning it over to allow for easier access.

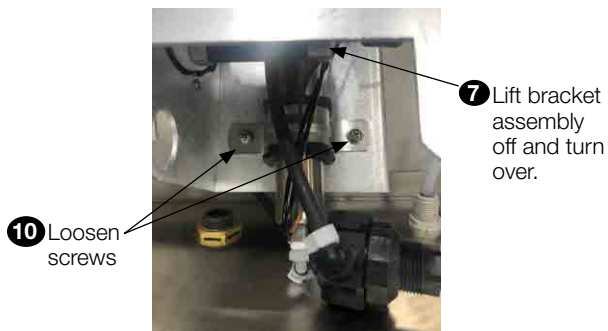

- Remove plastic hose clamps from 90° elbows, then remove tubing from the elbows.

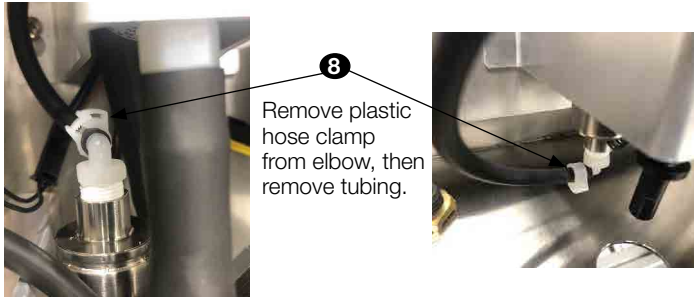

- Remove the panel nut that holds the regulator in place, then lower the regulator down through the bracket.
- Loosen the 2 screws that hold the heater mounting clamp in place.
- Slide the heater and connected wiring out of the clamp. Make sure to observe the orientation and position of the heater prior to removal.
- Insert new heater into the clamp, making sure the flow direction and orientation is the same as the old one removed in Step 11.
- Tighten the 2 screws that go to the heater mounting clamp, making sure heater is secure.
- Connect tubing to the inlet and outlet elbows on heater, then secure with new clamps provided.
- Turn intake assembly back over and place it back on the 2 screws that hold it to the back panel. Tighten screws once assembly is in place.
- Place the regulator back into the bracket and secure into place with panel nut.
- Reconnect the water line and the drain line that was removed in Steps 2 & 3.
- Route new wiring through corrugated sleeving into the electronics compartment.
- Reconnect the red & yellow thermocouple wires to the connector, then plug back into the main measurement board, making sure of proper orientation/placement of the connector and wires.
- Reconnect the two black heater wires to the main measurement board.
- Turn water supply to MCX instrument back on.
- Turn MCX instrument on and check for leaks.

Accessories and Replacement Parts List

Catalog Number	Accessory Description
25018S	Replacement Cuvette
28056	MCX Instrument
28141S	Pump Head Replacement Kit
28158S	Pressure Regulator Assembly
28182S	Complete Tubing Replacement Kit
28178S	Reagent Kit
28164S	Air Pump Kit
28181S	Reagent Pump Kit
100240	Operation Manual, MCX
28172S	Heater Replacement Kit
28176S	Grab Sample Kit, External
28179S	Cap and Inlet Tubing Kit
28180S	Replacement Thermocouple
100239S	Replacement USB
110154S	Light Shield Tether
28188S	MCX Flush Kit

To order any accessory or replacement parts, please contact the HF scientific Customer Service Department.

HF scientific
 16260 Airport Park Drive, Suite 140
 Fort Myers, FL 33913
 Phone: 239-337-2116
 Toll Free: 888-203-7248
 Fax: 239-454-0694
 Email: hf.info@wattswater.com
 Website: www.hfscientific.com

Troubleshooting

Operational

Symptoms	Possible Cause	Solution
4-20mA output repeats 2-3 times. (Frozen reading)	Fault Error.	Visually inspect the instrument and correct the fault.
No sample water intake.	Inlet water line clogged.	Add a filter to the inlet water line.
All readings are zero.	Empty reagent or empty indicator.	Follow the procedure to flush lines and replace reagents.
	Reagent pumps are not actuating.	Check electrical connections. Perform a reagent prime under the service menu. Replace the Reagent pump assembly.
Free Ammonia reading is zero.	Chlorinating solution delivery.	Replace reagent if empty.
	Empty Chlorinating solution.	Prime chlorinating solution.
No Water flow.	Internal Pressure Regulator set point.	Adjust the pressure regulator. Turn the knob clockwise for increased flow.
	Peristaltic pump head unseated.	Reattach the pump head.
	Peristaltic pump motor not running.	Check the electrical connections up to the electronics compartment. Press Mode to enter service mode and prime the water. If the motor does not run, then call technical support.
	Peristaltic pump head failure.	Replace the pump head (should last approximately one year).
	Closed sample water flow.	Ensure the valve is open to sample flow line. Disconnect push connect the fitting at the base of the instrument.
Erratic Readings	Reagent supply tubing worn.	Replace complete reagent tubing (recommended replacement time is 6 months).
	High sample water pressure.	1) Check the internal pressure regulator functions by removing the adjustment screw completely. Water should not flow into the sample cuvette when priming the water. 2) If high sample water pressure persist, replace the pressure regulator
Low Readings compared to hand helds.	Low reagent delivery.	Perform the tubing flush and prime procedure. Visually inspect reagent pump operation. Tighten thumb screws on pump hammers. Remove the reagent pump hammers and inspect the hammer springs. If the springs are bound, disassemble and unbind the spring and reassemble.
Evidence of water in the enclosure.	Leaking cuvette.	Remove and reseal the sample cuvette. See cuvette cleaning procedure.
	Peristaltic pump tubing failure.	Remove the peristaltic pump head for inspection. If the tubing has failed, replace pump head.

Symptoms	Possible Cause	Solution
Blank display.	Display board connection.	Check electrical connections to the display board.
Analog output is not reading accurately.	Output requires adjustment.	Trim the analog output, see Selecting the Analog Output section of this manual.
Water exiting the overflow drain on side of enclosure.	The drain line is either slow draining or blocked.	Inspect the drain line for unobstructed flow to an atmospheric drain. Inspect the line for kinks or blockages.

For technical assistance, please contact the HF scientific Technical Services Department.

HF scientific
16260 Airport Park Drive, Suite 140
Fort Myers, FL 33913
Phone: 239-337-2116
Toll Free: 888-203-7248
Fax: 239-454-0694
Email: hf.info@wattswater.com
Website: www.hfscientific.com

Halting Errors

Halting errors are displayed as a red banner. Any time there is a halting error, press the exit button and the left arrow button at the same time and the system will reset.

WARNING

Remove power to the instrument when checking any electrical connections in the instrument. If power can not be disconnected, there is the option of removing the electrical connector to the power supply.

Halting Error	Possible Cause	Solution
Buffer pump error.	Buffer reagent pump is not able to turn on/off.	Go to the service screen and choose prime then prime buffer and observe the buffer pump for activity. If the pump does not run, check wire connections at the main measurement board and the pump.
Indicator pump error.	Indicator reagent pump is not able to turn on/off.	Go to the service screen and choose prime then prime indicator and observe the indicator pump for activity. If the pump does not run, check wire connections at the main measurement board and the pump.
Air pump error.	Air pump is not able to turn on/off.	Go to the service screen and choose prime then prime air and observe the air pump for activity. If the pump does not run, check wire connections at the main measurement board and the pump.
Chlorinating Solution pump error.	Chlorinating solution reagent pump is not able to turn on/off.	Go to the service screen and choose prime then prime chlorinating solution and observe the chlorinating solution pump for activity. If the pump does not run, check wire connections at the main measurement board and the pump.

Halting Error	Possible Cause	Solution
Photodiode ADC error.	When photodiode is not providing absorption values. (ADC value). Failure on the detector.	1) Inspect the cuvette. Clean the cuvette if a build up is visible. 2) Inspect that the ribbon cable connected to the optical board is secured properly. 3) If the error persist, press Mode twice, enter 555555, then press enter to Enable Admin. Press Exit to go to home screen. Press Mode twice to go to Configuration. Scroll down to Diagnostics and press the Enter Arrow. First Press right arrow to select Measurement LED and press the enter arrow. Then Press the Enter Arrow to turn on the LED. Observe that the LED turns on. If the LED turns on, then follow the instruction for replacing the optical board to remove the board and follow the instruction to clean the photodiode.
Optical board absent/wrong.	When optical board is not connected or different optical board is connected.	Inspect that the ribbon cable connected to the optical board is secured properly. If the error persist then call technical support.
LED Optimization error.	When binary search algorithm for LED optimization fails.	Inspect the light pipe connections to the LEDs on the optical board. The optical board will need to be replaced.
Measurement RED LED error.	When measurement red led is not able to turn on/off.	Inspect the light pipe connections to the LEDs on the optical board. If the light pipes are connected properly and error persists, then call technical support.
Water detect RED LED error.	When water detect red led is not able to turn on/off.	Inspect the light pipe connections to the LEDs on the optical board. If the light pipes are connected properly and error persists, the call technical support.
Stepper Motor error.	When stepper motor goes to fault condition.	Go to the service screen: Press the MODE button then press the ← twice. Prime water will be selected. Press the ←. Observe the cuvette water flow. If water does flow into the cuvette then exit Prime menu and start another reading cycle. If the error persists then call technical support. If water does not flow into the cuvette, call technical support.
Drain valve error.	When drain valve is not able to turn on/off.	1) Press Mode twice to enter the Configuration menu, then use arrow keys to navigate to Diagnostics. Choose Fill and observe that the cuvette fill with water. Then select Drain and observe the cuvette drains. 2) If the Drain valve does not run, check wire connections at the main measurement and the pump. See Main Board drawing on page 5 for connection locations. 3) If the Drain valve operates and the cuvette empties then exit the Configuration menu and initiate a reading cycle. If error persists, then call technical support.

Halting Error	Possible Cause	Solution
Communication error	When data communication between boards is not happening.	1) Verify the instrument grounding cable is in place. *Remove power before proceeding to the next steps. 2) Check the blue and yellow RJ45 connections on the display board. 3) Check ribbon cable connection from the main measurement to UI board. 4) Check the screws that secure the UI board to the main measurement board are tight/secure.
MMB CPU thermal error.	When Main Measurement Board CPU temperature is above threshold.	Remove power to the instrument. Call technical support. Replacement of the main measurement board is required.
UIB CPU thermal error	When User Interface board CPU temperature is above threshold.	Remove power to the instrument. Call technical support. Replacement of the main measurement board is required.
DIB CPU thermal error.	When display board CPU temperature is above threshold.	Remove power to the instrument. Call technical support. Replacement of the main measurement board is required.

For technical assistance, please contact the HF scientific Technical Services Department.

HF scientific
16260 Airport Park Drive, Suite 140
Fort Myers, FL 33913
Phone: 239-337-2116
Toll Free: 888-203-7248
Fax: 239-454-0694
Email: hf.info@wattswater.com
Website: www.hfscientific.com

Non-Halting Errors

For technical assistance, please contact the HF scientific Technical Services Department.

HF scientific
 16260 Airport Park Drive, Suite 140
 Fort Myers, FL 33913
 Phone: 239-337-2116
 Toll Free: 888-203-7248
 Fax: 239-454-0694
 Email: hf.info@wattswater.com
 Website: www.hfscientific.com

Non-Halting Error	Possible Cause	Solution
Reading error	When there is error in reading because of wrong ADC value	Disregard the readings from this cycle and allow the instrument to run another cycle.
Backlight LED on error.	When backlit LED is not turning on.	Inspect the light pipe connections to the LEDs on the optical board. Inspect that the ribbon cable connected to the optical board is secured properly. If the error persist then call technical support. The Instrument can continue to operate correctly.
No water intake error.	When there is no water inside cuvette after the first try.	1) Check that sample water supply is not turned off to the instrument. 2) Visual check that the cuvette is clean and clear. If the cuvette is visually clouded over with calcium scale proceed to step 3, cleaning the cuvette. 3) Follow the cuvette and heater cleaning procedure.
Backlight LED off error.	When backlit LED is not turning off.	1) Check wire connection to the optical board.
Stepper motor command warning.	When stepper motor is not responding to commands,	Follow the stepper motor trouble shooting above.
Stepper motor thermal warning.	When stepper motor temperature is high.	Threshold is 130°F
MMB CPU warm.	When Main Measurement Board CPU is warm and below the threshold value.	Threshold is 100°F
UIB CPU warm.	When User Interface Board CPU is warm and below the threshold value.	Threshold is 100°F
DIB CPU warm.	When Display Board CPU is warm and below the threshold value.	Threshold is 100°F
NH2Cl-C12 Over Range.	When NH2Cl-C12 value is over the instrument measurement range for NH2Cl-C12.	Please understand the readings outside of the instrument measurement range may not be accurate.
Total NH3-N Over Range.	When Total NH3-N value is over the instrument measurement range for Total NH3-N.	Please understand the readings outside of the instrument measurement range may not be accurate.
Free NH3-N Over Range.	When Free NH3-N value is over the instrument measurement range for Free NH3-N.	Please understand the readings outside of the instrument measurement range may not be accurate.
Heater timeout error.	Heater is scaled or non functional.	Follow the heater cleaning procedure. If the error persist, start a new reading cycle. Once it reaches the heating step, go into the Diagnostics then select Environment. If the temperature for the Heater thermocouple is not increasing. Then inspect the flow of the incoming sample water has stopped and not flow is running through the overflow. If water is exiting through the overflow, then inspect the incoming regulators to ensure proper operation. Water pressure entering the instrument should not exceed 50psi.

Warranty

HF scientific, LLC (the "Company") warrants each municipal market instrument product to be free from defects in material and workmanship under normal usage for a period of two (2) years from date of the Company's invoice from the original sale of the product. In the event of such defects within the warranty period, the Company will, at its option, replace or recondition the product without charge. Parts which by their nature are normally required to be replaced periodically, consistent with normal maintenance, specifically reagents, desiccant, sensors, electrodes and fuses, are excluded. Also excluded are accessories and supply-type items.

Proof of purchase from the Company (Company invoice or paid order confirmation) and/or first use (commissioning) must be provided when making a product warranty claim.

THE WARRANTY SET FORTH HEREIN IS GIVEN EXPRESSLY AND IS THE ONLY WARRANTY GIVEN BY THE COMPANY WITH RESPECT TO THE PRODUCT. THE COMPANY MAKES NO OTHER WARRANTIES, EXPRESSED OR IMPLIED. THE COMPANY HEREBY SPECIFICALLY DISCLAIMS ALL OTHER WARRANTIES, EXPRESSED OR IMPLIED, INCLUDING BUT NOT LIMITED TO, THE IMPLIED WARRANTIES OR MERCHANTABILITY AND FITNESS FOR A PARTICULAR PURPOSE.

The remedy described in the first paragraph of this warranty shall constitute the sole and exclusive remedy for breach of warranty, and the Company shall not be responsible for any incidental, special or consequential damages, including without limitation, lost profits or the cost of repairing or replacing other property which is damaged if this product does not work properly, other costs resulting from labor charges, delays, vandalism, negligence, fouling caused by foreign material, damage from adverse water conditions, chemical, or any other circumstances over which the Company has no control. In addition, the Company shall not be responsible for any costs incidental to the Company's warranty response efforts, including, without limitation, costs associated with the removal and replacement of systems, structures or other parts of facilities, de-installation, decontamination and re-installation of products, or transportation of products to and from the Company. This warranty shall be invalidated by any abuse, misuse, misapplication, improper installation or improper maintenance of the product, alteration of the product or use of any parts or accessories (including but not limited to reagents) not provided by the Company.

Some states do not allow limitations on how long an implied warranty lasts, and some states do not allow the exclusion or limitation of incidental or consequential damages. Therefore the above limitations may not apply to you. This Limited Warranty gives you specific legal rights, and you may have other rights that vary from State to State. You should consult applicable state laws to determine your rights. **SO FAR AS IS CONSISTENT WITH APPLICABLE STATE LAW, ANY IMPLIED WARRANTIES THAT MAY NOT BE DISCLAIMED, INCLUDING THE IMPLIED WARRANTIES OF MERCHANTABILITY AND FITNESS FOR A PARTICULAR PURPOSE, ARE LIMITED IN DURATION TO ONE YEAR FROM THE DATE OF ORIGINAL SHIPMENT.**



A WATTS Brand

USA: T: (239) 337-2116 • Toll-Free (888) 203-7248 • F: (239) 454-0694 • HFscientific.com

Latin America: T: (52) 55-4122-0138 • HFscientific.com