

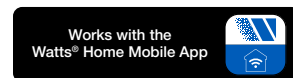

Installation, Operation and Maintenance Manual

WiFi Snow Melting Control 671



⚠ WARNING

 Please read carefully before proceeding with installation. Your failure to follow any attached instructions or operating parameters may lead to the product's failure.

 **THINK SAFETY FIRST**

Keep this Manual for future reference.

Table of Contents

Important Safety Information.....	3	Sequence of Operation.....	25
Radio Frequency Interference.....	3	Snow Melting Overview	25
Installation.....	4	Melt – Automatic Start and Stop.....	25
Preparation.....	4	Melt – EconoMelt.....	26
Packaging Contents.....	4	Additional Melting Time.....	26
Physical Dimensions	4	Melt – Automatic Start and Timed Stop	26
Installation Location	4	Tandem Snow/Ice Detection.....	27
Installing the Enclosure	5	Melt – Manual Start and Timed Stop.....	27
Rough-In Wiring	6	Melt - Tracked Start and Stop.....	27
Sensor Wiring	7	Idle Operation.....	28
tekmarNet®.....	8	Storm Operation.....	28
Manual Melt Input.....	8	Slab Temperature Control.....	29
Equipment Wiring.....	9	Snow Melt Zones and Priority.....	29
Testing the Sensor Wiring.....	10	Warm Weather Shut Down.....	31
Testing the Control Wiring.....	10	Cold Weather Cut Off.....	31
Manual Override – Maximum Heat	11	Time Clock.....	31
Manual Override – Purge.....	11	Away Operation.....	31
Manual Override – Off.....	11	tekmarNet Scene Operation	31
Access Levels.....	11	Pulse Width Modulation Zone Operation.....	32
User Interface.....	12	Outdoor Sensor.....	32
Home Screen.....	12	Exercising	32
System Operation	12	Post Purge.....	32
Symbols.....	13	Troubleshooting	33
Help Screen.....	13	Error Messages (1 of 2)	33
Status Menu Navigation.....	13	Error Messages (2 of 2)	34
System Status Menu	14	Frequently Asked Questions.....	35
Slab Status Screen.....	14	Technical Data.....	35
Weather Status Screen	15	Limited Warranty and Product Return Procedure	36
Settings Menu Navigation.....	15		
Temp Menu.....	17		
Away Menu	18		
Display Menu.....	18		
WiFi Menu.....	19		
Time Menu.....	19		
WiFi and Connectivity Troubleshooting.....	20		
Energy Menu	21		
Monitor Menu	21		
Setup – System Setup Menu	22		
Setup – Boiler Setup Menu	22		
tekmarNet Menu.....	23		
Toolbox Menu.....	24		
Override Menu.....	24		

Getting Started

Congratulations on the purchase of your new Snow Melting Control!

This manual covers the complete installation, programming and sequence of operation for this control. You will also find instruction on testing, commissioning, and troubleshooting the control and system that it operates.

Important Safety Information

It is your responsibility to ensure that this control is safely installed according to all applicable codes and standards. tekmar® is not responsible for damages resulting from improper installation and/or maintenance.



This is a safety-alert symbol. The safety alert symbol is shown alone or used with a signal word (DANGER, WARNING, or CAUTION), a pictorial and/or a safety message to identify hazards. When you see this symbol alone or with a signal word on your equipment or in this manual, be alert to the potential for death or serious personal injury.



This pictorial alerts you to electricity, electrocution, and shock hazards.

▲ WARNING

This symbol identifies hazards which, if not avoided, could result in death or serious injury.

▲ CAUTION

This symbol identifies hazards which, if not avoided, could result in minor or moderate injury.

NOTICE

This symbol identifies practices, actions, or failure to act which could result in property damage or damage to the equipment.

▲ WARNING



Read manual and all product labels BEFORE using the equipment. Do not use unless you know the safe and proper operation of this equipment. Keep this manual available for easy access by all users. Replacement manuals are available at tekmarControls.com

▲ WARNING

- It is the installer's responsibility to ensure that this control is safely installed according to all applicable codes and standards.
- Improper installation and operation of this control could result in damage to the equipment and possibly even personal injury or death.
- This control is not intended for use as a primary limit control. Other controls that are intended and certified as safety limits must be placed into the control circuit.

NOTICE

Do not attempt to service the control. There are no user serviceable parts inside the control. Attempting to service the control voids the warranty.

Radio Frequency Interference

The installer must ensure that this control and its wiring are isolated and/or shielded from strong sources of electromagnetic noise. Conversely, this Class B digital apparatus complies with Part 15 of the FCC Rules and meets all requirements of the Canadian Interference-Causing Equipment Regulations. However, if this control does cause harmful interference to radio or television reception, which is determined by turning the control off and on, the user is encouraged to try to correct

the interference by re-orientating or relocating the receiving antenna, relocating the receiver with respect to this control, and/or connecting the control to a different circuit from that to which the receiver is connected.

Cet appareil numérique de la classe B respecte toutes les exigences du Règlement sur le matériel brouilleur du Canada.

Installation

Preparation

Tools Required

- tekmar or jeweler screwdriver
- Phillips head screwdriver
- Needle-nose pliers
- Wire stripper

Materials Required

- 18 AWG LVT solid wire (low-voltage connections)
- 14 AWG solid wire (line-voltage connections)
- Four 1/8" - 1" wood screws

Packaging Contents

The following are included in the product packaging:

- 1 WiFi Snow Melting Control 671
- 1 Outdoor Sensor 070
- 1 screwdriver
- 1 Application Brochure 671_A
- 1 Installation and Operation Manual 671_D
- 1 User Manual 671_U

Physical Dimensions

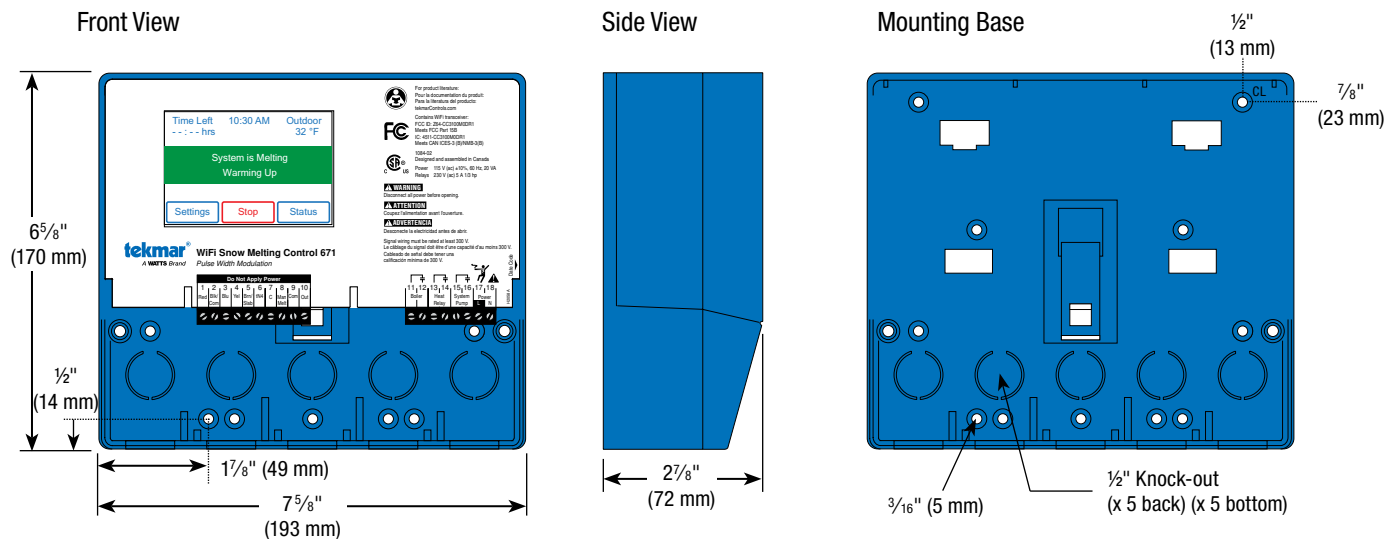

Installation Location

Choose the placement of the control early in the construction process to enable proper wiring during rough-in.

NOTICE

- Keep the control dry. Avoid potential leakage onto the control.
- Maintain relative humidity less than 90% in a non-condensing environment.
- Avoid exposure to extreme temperatures beyond 32-122°F (0-50°C).
- Install away from equipment, appliances, or other sources of electrical interference.
- Install to allow easy access for wiring, viewing, and adjusting the display screen.
- Install approximately 5 feet (1.5 m) off the finished floor.
- Locate the control near pumps and/or zone valves if possible.
- Provide a solid backing which the enclosure can be mounted to. Example: plywood or wall studs.
- Use the conduit knockouts provided on the upper, lower, back and sides of the enclosure for wiring.

Installing the Enclosure

- Install the control enclosure to a wall or to an electrical box.
- Three wiring chamber dividers are included. The dividers provide a barrier to keep low voltage wiring separated from line voltage wiring.
- If the dividers are not used, then low voltage circuits must use wire rated at least 300 V.

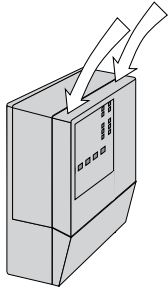

Press down at the fingertip grips on top of the front cover and pull out and down.

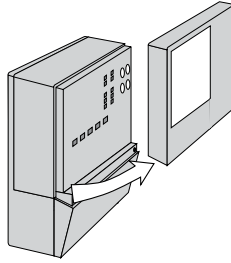

Lift the front cover up and away from the control.

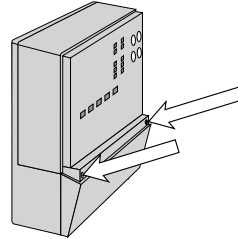

Loosen the screws at the front of the wiring cover.

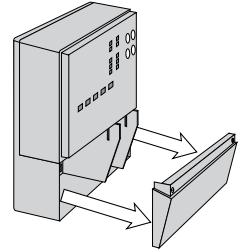

The wiring cover pulls straight out from the wiring chamber.

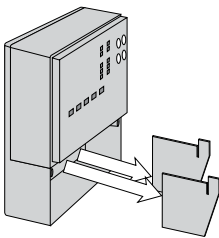

Remove the safety dividers from the wiring chamber by pulling them straight out of their grooves.

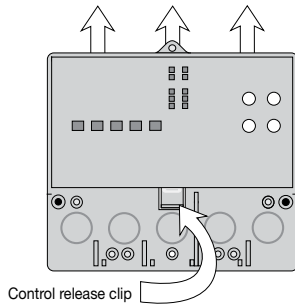

Press the control release clip on the base inside the wiring chamber and slide the control upwards.

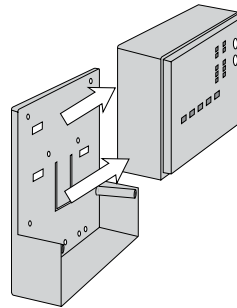

The control lifts up and away from the base.

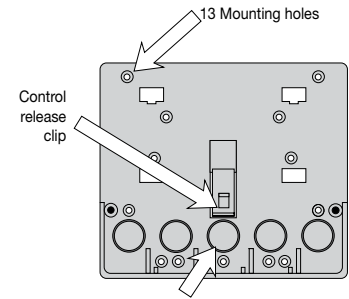

There are 10 conduit knock-outs at the back and bottom of the wiring chamber.

The base is ready for mounting.

The control can be mounted on a standard DIN rail. First remove the control from its base and then, using the hooks and spring clip on the back of the control, mount it onto the DIN rail. This will be a popular option for those who prefer to mount the control inside a larger electrical panel. The DIN Snap Kit M9303 is sold separately.

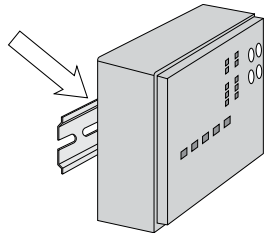

The wiring can enter the bottom or the back of the enclosure. Knock-outs provided in the base allow the wiring to be run in conduit up to the enclosure. The base also has holes that line up with the mounting holes of most common electrical boxes.

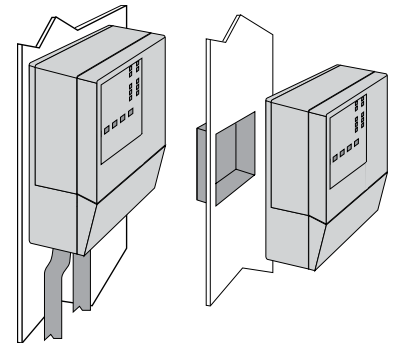

Rough-In Wiring

⚠ WARNING



To prevent the risk of personal injury and/or death, make sure power is not applied to the control until it is fully installed and ready for final testing. All work must be done with power to the circuit being worked on turned off. Please be aware local codes may require this control to be installed or connected by an electrician.

NOTICE

- Install the supplied wiring compartment barriers by sliding them into the grooves provided to isolate the low and line-voltage wiring.
- Strip all wiring to a length of 3/8 in. or 10 mm for all terminals.
- A circuit breaker or power disconnect that provides power to the control should be located nearby and clearly labeled.
- Refer to the current and voltage ratings at the back of this manual before connecting devices to this control.

Low-Voltage Wiring

Pull two conductor 18 AWG LVT cable, up to 500 feet (150 m) long, for the following equipment:

- Outdoor temperature sensor
- Boiler sensor
- Single-stage on/off boiler

Pull four conductor 18 AWG LVT cable, up to 500 feet (150 m) long, for the following equipment:

- Snow Sensor 095

Pull the Snow/Ice Sensor 090 or 094 cable to the control.

Line-Voltage Wiring

Pull two conductor 14 AWG cable, up to 500 feet (150 m) long, for the following equipment:

- System pump
- Boiler pump

Sensor Wiring

Mounting the Outdoor Sensor

- The temperature sensor (thermistor) is built into the sensor enclosure.
- The outdoor sensor can either be mounted directly onto a wall and the wiring should enter through the back or bottom of the enclosure. Do not mount the outdoor sensor with the conduit knockout facing upwards because rain could enter the enclosure and damage the sensor.
- In order to prevent heat transmitted through the wall from affecting the sensor reading, it may be necessary to install an insulating barrier behind the enclosure.
- The outdoor sensor should be mounted on a north-facing wall. The outdoor sensor should not be exposed to heat sources such as ventilation or window openings.
- The outdoor sensor should be installed at an elevation above the ground that will prevent accidental damage or tampering.

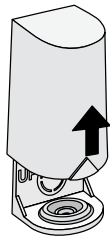

Remove cover by sliding upwards away from the base.

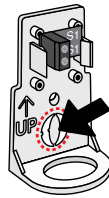

To wire from the back, remove the knock-out in the sensor base.

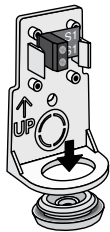

If using conduit, remove the flexible plug from the base bottom.

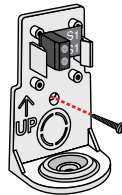

Attach the base to the wall, soffit or electrical box.

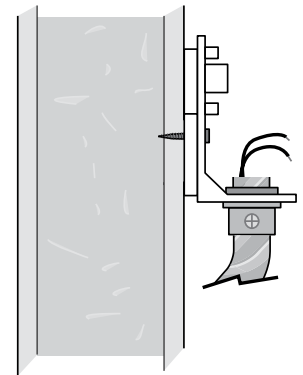
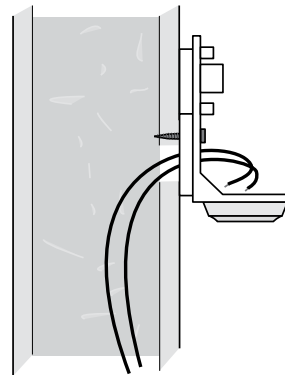

Wiring the Outdoor Sensor

- Connect 18 AWG or similar wire to the two terminals provided in the enclosure and run the wires from the outdoor sensor to the control. Do not run the wires parallel to telephone or power cables. If the sensor wires are located in an area with strong sources of electromagnetic interference (EMI), shielded cable or twisted pair should be used or the wires can be run in a grounded metal conduit. If using shielded cable, the shield wire should be connected to the Com terminal on the control and not to earth ground.
- Follow the sensor testing instructions in this manual and connect the wires to the control.
- Replace the front cover of the sensor enclosure.

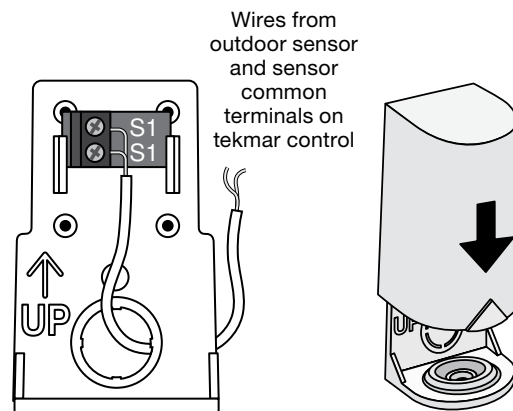

At the control:

- Connect the outdoor sensor to terminals 9 and 10.

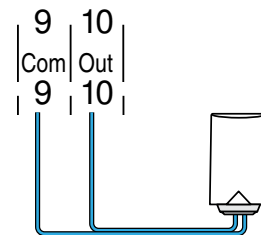

Snow/Ice Sensor

A Snow/Ice Sensor 090 or 094 can be connected to the control. The 090 has a 65' (20 m) cable and the 094 has a 208' (63 m) cable. The cable may be extended to a total length of 500' (150 m) using 18 AWG cable. Any junction boxes must kept dry.

If the Snow/Ice Sensor input is used:

- Connect the red wire to terminal 1.
- Connect the black wire to terminal 2.
- Connect the blue wire to terminal 3.
- Connect the yellow wire to terminal 4.
- Connect the brown wire to terminal 5.

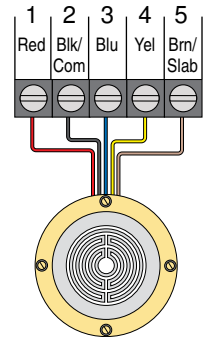

Snow Sensor

A Snow Sensor 095 can be connected to the control.

If the Snow Sensor input is used:

- Connect the red wire to terminal 1.
- Connect the black wire to terminal 2.
- Connect the blue wire to terminal 3.
- Connect the yellow wire to terminal 4.

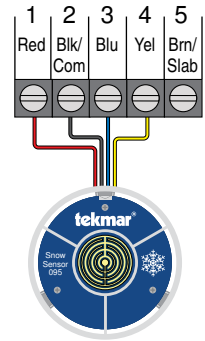

Slab Sensor

A Slab Sensor 072 or 073 can be installed either alone or together with a Snow Sensor 095.

If the Slab Sensor input is used:

Connect the slab sensor to terminals 2 and 5.

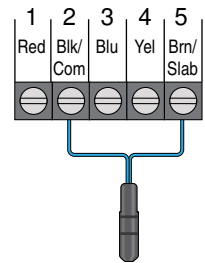

tekmarNet

The 671 can be connected to other tekmarNet communication compatible controls using the tN4 bus.

If tekmarNet is used:

- Connect tN4 on the 671 terminal 6 to the tN4 wiring terminal on the other device.
- Connect C on the 671 terminal 7 to the C wiring terminal on the other device.
- tekmarNet is polarity sensitive.

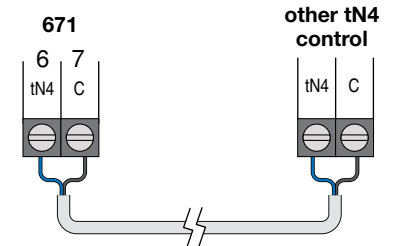

Manual Melt Input

The manual melt input allows the control to be manually switched to melting operation using a switch. This connection is optional.

If the Manual Melt input is used:

Connect a switch to terminals 8 and 9. The switch may be either dry (no voltage) or a voltage signal up to 32 V (ac).

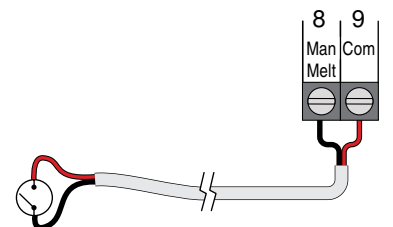

Equipment Wiring

Wiring to a Single-Stage Boiler

A single-stage boiler is enabled through the T-T contacts.

- Connect Boiler terminals 11 and 12 to the boiler T-T contacts.

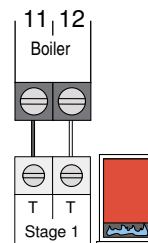

Wiring the Heat Relay

If the heat relay is operating a pump:

The pump can be rated up to 230 V (ac), 5 A, 1/3 hp and switched through terminals 13 and 14. For simplicity in wiring and troubleshooting, a separate breaker for each pump is recommended.

- Connect the power source line wire (L) to terminal 14.
- Connect a wire from terminal 13 to the pump L.
- Connect a wire from the pump N back to the power source neutral.
- Connect the ground wire (G) to the pump.

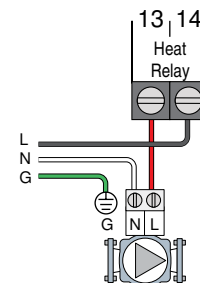

If the heat relay is wired to a 24 V(ac) on-off valve:

- Connect the power source red wire (R) to terminal 13.
- Connect a wire from terminal 14 to the valve R.
- Connect a wire from the valve C to the power source common.

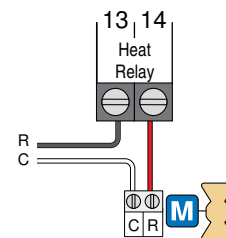

If the heat relay is wired to an electrical contactor:

- Connect a wire from terminal 13 to the electrical contactor R.
- Connect a wire from terminal 14 to the electrical contactor C.

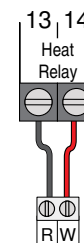

Wiring the System Pump

A system pump requiring up to 230 V (ac), 5 A, 1/3 hp can be switched through terminals 15 and 16. For simplicity in wiring and troubleshooting, a separate breaker for each pump is recommended.

- Connect the power source line wire (L) to terminal 16.
- Connect a wire from terminal 15 to the pump L.
- Connect a wire from the pump N back to the power source neutral.
- Connect the ground wire (G) to the pump.

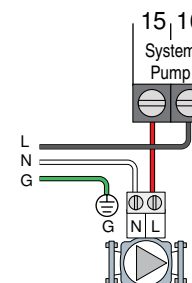

Wiring the Input Power

Provide a 15 A circuit for the input power.

- Connect the 115 V (ac) line wire (L) to terminal 17.
- Connect the neutral wire (N) to terminal 18.

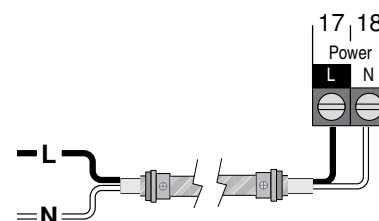

Testing the Sensor Wiring

A good quality test meter capable of measuring up to 5,000 k Ω (1 k Ω = 1000 Ω) is required to measure the sensor resistance. In addition, the actual temperature must be measured with either a high-quality digital thermometer, or if a thermometer is not available, a second sensor can be placed alongside the one to be tested and the readings compared.

First, measure the temperature using the thermometer and then measure the resistance of the sensor at the control. The wires from the sensor must not be connected to the control while the test is performed. Using the chart below, estimate

the temperature measured by the sensor. The sensor and thermometer readings should be close. If the test meter reads a very high resistance, there may be a broken wire, a poor wiring connection or a defective sensor. If the resistance is very low, the wiring may be shorted, there may be moisture in the sensor or the sensor may be defective. To test for a defective sensor, measure the resistance directly at the sensor location.

Do not apply voltage to a sensor at any time as damage to the sensor may result.

Temperature		Resistance	Temperature		Resistance	Temperature		Resistance	Temperature		Resistance
$^{\circ}\text{F}$	$^{\circ}\text{C}$	Ω	$^{\circ}\text{F}$	$^{\circ}\text{C}$	Ω	$^{\circ}\text{F}$	$^{\circ}\text{C}$	Ω	$^{\circ}\text{F}$	$^{\circ}\text{C}$	Ω
-50	-46	490,813	20	-7	46,218	90	32	7,334	160	71	1,689
-45	-43	405,710	25	-4	39,913	95	35	6,532	165	74	1,538
-40	-40	336,606	30	-1	34,558	100	38	5,828	170	77	1,403
-35	-37	280,279	35	2	29,996	105	41	5,210	175	79	1,281
-30	-34	234,196	40	4	26,099	110	43	4,665	180	82	1,172
-25	-32	196,358	45	7	22,763	115	46	4,184	185	85	1,073
-20	-29	165,180	50	10	19,900	120	49	3,760	190	88	983
-15	-26	139,403	55	13	17,436	125	52	3,383	195	91	903
-10	-23	118,018	60	16	15,311	130	54	3,050	200	93	829
-5	-21	100,221	65	18	13,474	135	57	2,754	205	96	763
0	-18	85,362	70	21	11,883	140	60	2,490	210	99	703
5	-15	72,918	75	24	10,501	145	63	2,255	215	102	648
10	-12	62,465	80	27	9,299	150	66	2,045	220	104	598
15	-9	53,658	85	29	8,250	155	68	1,857	225	107	553

Testing the Control Wiring

Remove the front cover from the control.

Testing the Power

- Use an electrical meter set to measure (ac) voltage.
- Measure between the L and N terminals.
- The reading should be 115 V (ac) +/- 10%.

Hand Manual Override

The control includes a Hand Manual Override menu to check if the control's relays are operating and that the control is wired correctly to the snow melting equipment.

Step 1: Press Settings button.

Step 2: Press Override button.

Step 3: Press Manual Override.

Step 4: Select Manual Override to Hand.

Step 5: Press Back button.

Step 6: The following outputs can be operated:

- System Pump relay
- Heat Relay
- Boiler Relay

For each relay output

- Use an electrical meter set to measure (ac) voltage.
- Measure between the relay wiring terminals.
- When the relay is off, the voltage should be 115 V (ac).
- When the relay is on, the voltage should be 0 V (ac).

Exiting the Hand Manual Override

- Exit the Manual Override by selecting Auto.
- Install the front cover.

Manual Override – Maximum Heat

In hydronic application modes, the control includes a Maximum Heat operation where the control operates the snow melting system to maintain the maximum allowed heating setpoints. This allows testing of the snow melting system during warm weather.

- Step 1: Press Settings button.
- Step 2: Press Override button.
- Step 3: Press Manual Override.
- Step 4: Select Manual Override to Max Heat.
- Step 5: Press Back button. The control starts the Max Heat operation.
- Step 6: Exit the Manual Override by selecting Auto.

Manual Override – Purge

When operating a hydronic snow melting system, it is necessary to purge and bleed all air out of the system. The control includes a Purge operation where the system, primary and boiler pumps are all turned on to assist in purging air from the system.

- Step 1: Press Settings button.
- Step 2: Press Override button.
- Step 3: Press Manual Override.
- Step 4: Select Manual Override to Purge.
- Step 5: Press Back button. The control starts the Purge operation.
- Step 6: Exit the Manual Override by selecting Auto.

Manual Override – Off

The snow melting system can be manually turned off and the control remains off until manually changed back to Auto. This allows the installer or end user to permanently disable the snow melting system without removing power from the control.

- Step 1: Press Settings button.
- Step 2: Press Override button.
- Step 3: Press Manual Override.
- Step 4: Select Manual Override to Off.
- Step 5: Press Back button. The control is now in the off manual override.
- Step 6: Exit the Manual Override by selecting Auto.

Access Levels

The control is shipped pre-programmed with common settings. The control has an “Installer” access level that allows full access to all settings and a “User” access level that restricts the number of settings available. The control defaults to the “User” access level after 12 hours of operation.

To change to the “Installer” access level:

- Step 1: Press the Settings button.
- Step 2: Press the Toolbox button.
- Step 3: Press Access Level.
- Step 4: Press the Installer radio button.

User Interface

Home Screen

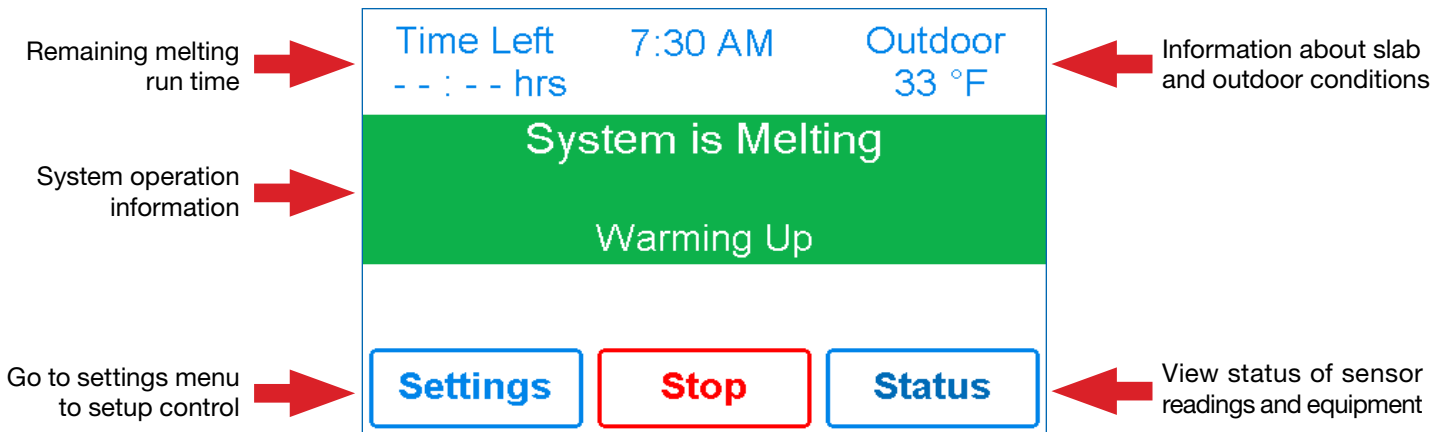

System Operation

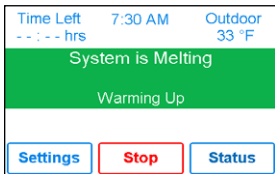

SYSTEM IS MELTING

- The control has either detected snow/ice and automatically started or the control was manually started.
- “Warming Up” is shown when the slab is below the slab target temperature.

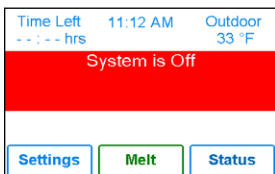

SYSTEM IS OFF

- The snow melting system is off and is ready to detect snow or ice.
- “Warm Weather Shut Down” is shown when the slab and outdoor temperature are above the WWSD setting. During WWSD, the snow will melt naturally due to warm outdoor temperatures.
- “Cold Weather Cut Off” is shown when the outdoor temperature is below the CWCO setpoint. The outdoor temperature is so cold the heating system does not have capacity to melt snow.
- “Melt Pending” is shown when the system is off during CWCO but will resume melting once the outdoor temperature increases above the CWCO setpoint.

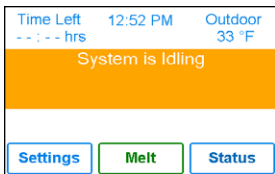

SYSTEM IS IDLING

- The control is pre-heating the slab to the idling setpoint. This reduces the amount of time needed to reach the melting setpoint in the event snow or ice is detected.

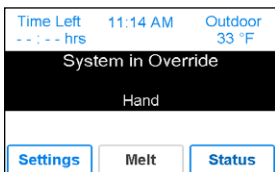

SYSTEM IN OVERRIDE / SYSTEM IN EXERCISING

- The control is in a manual override for testing, commissioning or exercising.
- The description field explains which type of override is active.

Symbols



WARNING SYMBOL

The control has an error message. Press the warning symbol to determine the error code and information on how to take corrective action. Refer to the Troubleshooting section for a list of error codes.

Help Screen

The display includes a Help screen for each setting. The Help screen provides a description of the setting that is identical to the description found in the Installation and Operation Manual.

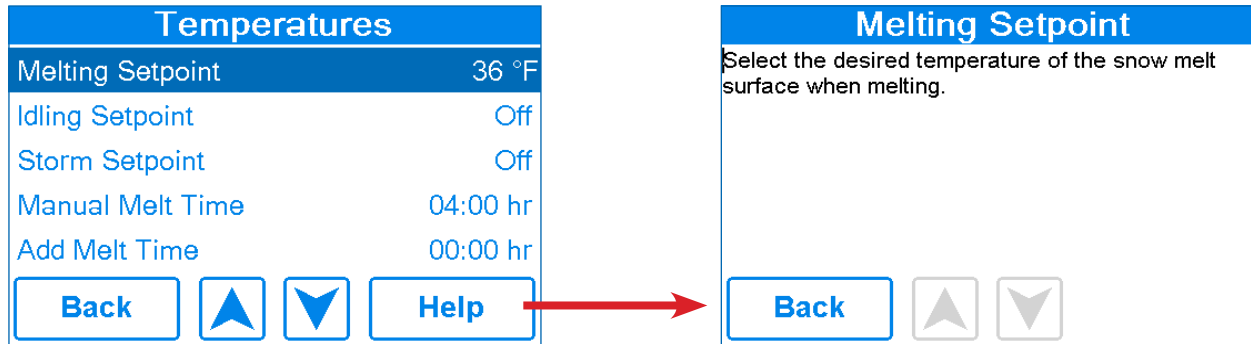

Status Menu Navigation

- Step 1: Press the Status button on the Home Screen.
- Step 2: Press either the System, Slab or Weather button.
- Step 3: Press up or down buttons to scroll through the list.

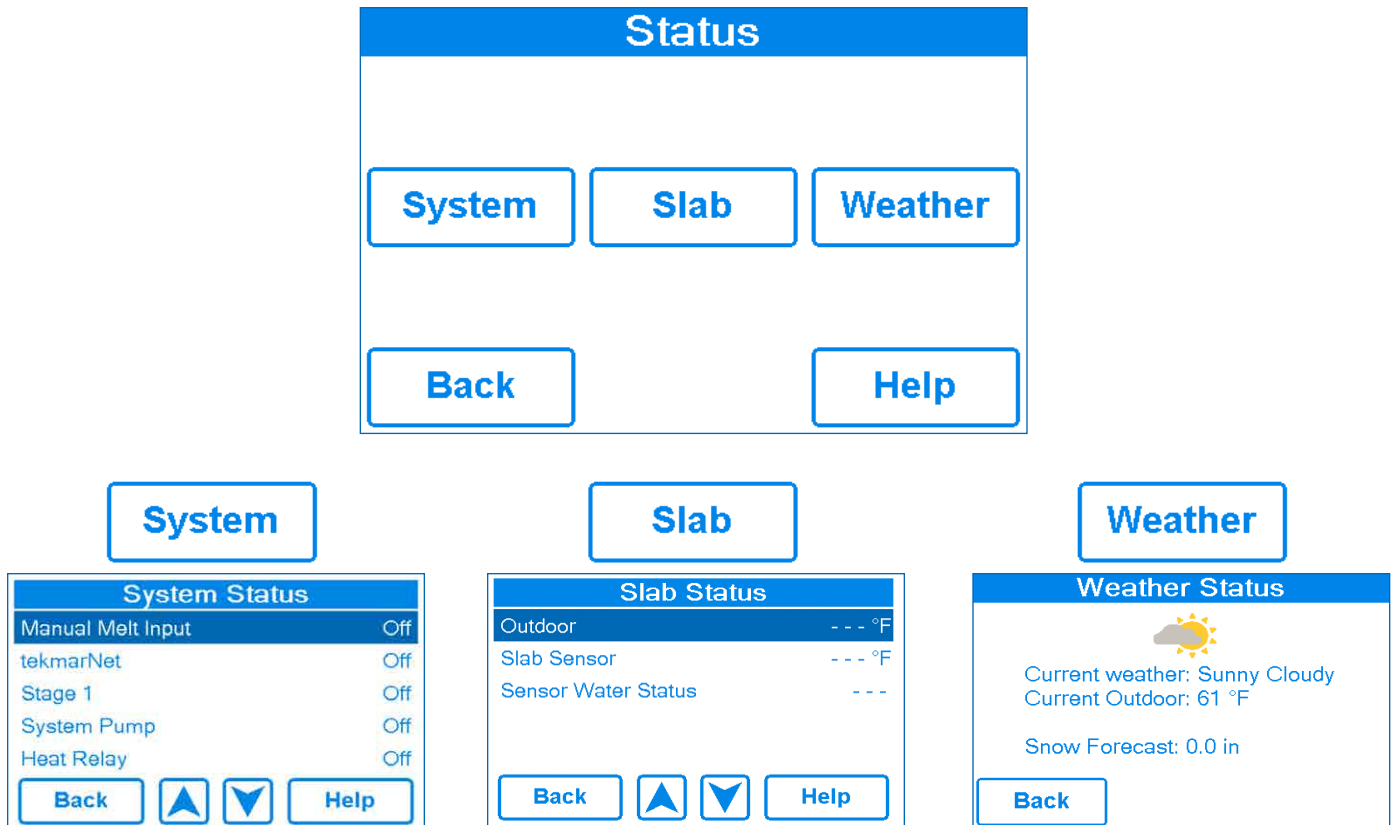

System Status Menu

Description	Range	Access
MANUAL MELT INPUT When Manual Melt wiring terminal 8 is shorted to common wiring terminal 9, the control is enabled and enters the melting operation unless prevented by warm weather shut down or cold weather cut off. When the manual melt input is disconnected, the control completes the melting cycle and then returns to off, idle or storm operation. Conditions: Available	Off, Enabled	User Installer
TEKMARNET When tekmarNet communication is present, the status shows active. When there is no tekmarNet communication, the status is off. Conditions: Available	Off, Active	User Installer
BOILER Current status of the Boiler relay. Conditions: Always available	On or Off	User Installer
SYSTEM PUMP Current status of the system loop pump. Conditions: Always available	On or Off	User Installer
HEAT RELAY Current status of the heat relay. Conditions: Always available	On or Off	User Installer

Slab Status Screen

Description	Range	Access
OUTDOOR Current outdoor air temperature as measured by the outdoor sensor or from the tekmarNet system. “---” is displayed when no outdoor temperature reading is available.	---, -67 to 149°F (-55.0 to 65.0°C)	User Installer
SLAB TARGET The slab target calculated by the control based on outdoor temperature and the melting, idling, or storm setpoints. “---” is displayed when no heat is required.	---, 32 to 110°F (0 to 43.0°C)	User Installer
SLAB SENSOR Current slab sensor temperature.	-58 to 167°F (-50.0 to 75.0°C)	User Installer
SENSOR WATER STATUS Current status of snow/ice sensor moisture detector.	DRY or WET	User Installer

Weather Status Screen

When WiFi is turned on, the control receives weather data from the Internet. The current weather, outdoor temperature and forecast snow fall information is displayed.

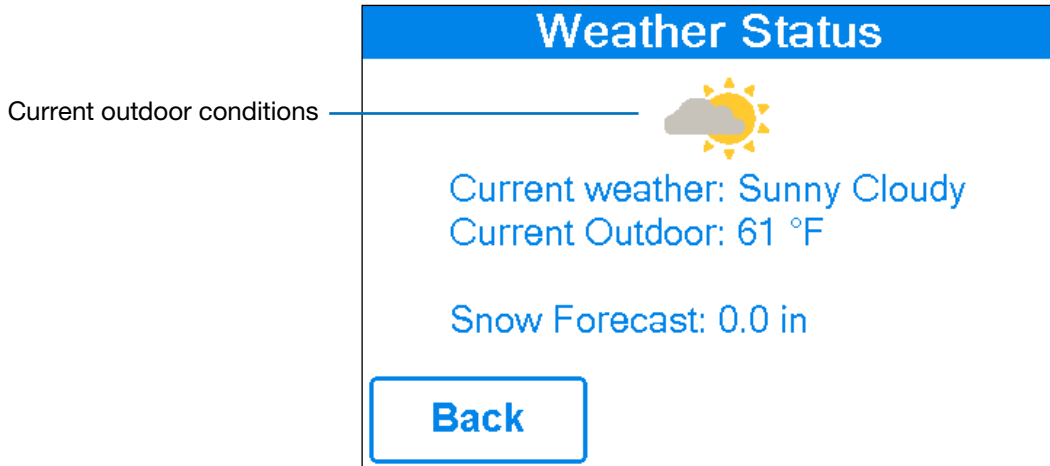

Settings Menu Navigation

Step 1: Press the Settings button on the Home Screen.

Step 2: Press one of the ten buttons.

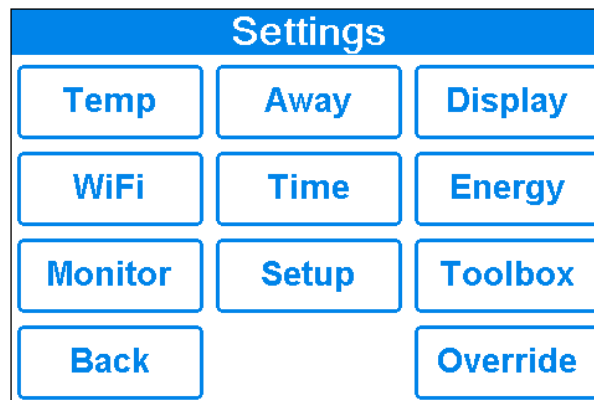

Step 3: Press up or down buttons to scroll through the list.

Step 4: Press the highlighted setting name to change the setting value.



Temp

Temperatures	
Melting Setpoint	36 °F
Idling Setpoint	Off
Storm Setpoint	Off
Manual Melt Time	04:00 hr
Sensitivity	Auto

Back   **Help**

Away

Away
<input checked="" type="radio"/> At Home
<input type="radio"/> Away

Back **Help**



Display

Display	
Temperature Units	°F
Screen Brightness	72 %
Clean Screen	No

Back   **Help**



WiFi

WiFi	
WiFi	On
Network SSID	
Postal/Zip	V1B3K4
Time Source	Auto

Back   **Help**

Time

Time	
Time Source	Auto
Time Format	12 hr
Time Zone	Eastern
Daylight Savings	On

Back   **Help**



Energy

Daily Usage	
Thu	1 hrs
Wed	0 hrs
Tue	0 hrs
Mon	0 hrs
Sun	0 hrs
Sat	0 hrs
Fri	0 hrs

Back **Monthly Usage** **Help**



Monitor

Monitor	
Melting Hours	3:37 hr
System Pump	3:38 hr
Slab Sensor High	--- °F
Slab Sensor Low	--- °F
Reset All	Off

Back   **Help**



Toolbox

Toolbox	
Access Level	Installer
Type 671	J1265-D A
Load Defaults	No
Calibrate Touchscreen	

Back   **Help**

Override

Override	
Manual Override	Auto

Back   **Help**

Temp Menu

Description	Range	Access
MELTING SETPOINT Select the desired temperature of the snow melt surface when melting.	32 to 95°F (0.0 to 35.0°C) Default = 36°F (2.0°C)	User Installer
IDLING SETPOINT Select the desired temperature of the snow melt surface when idling. Idling preheats the slab when the slab is dry but cold and allows faster reaction time to reach the melting temperature when snow is detected. Recommended for commercial use only.	OFF, 20 to 95°F (-6.5 to 35.0°C) Default = Off	User Installer
STORM SETPOINT Select the desired temperature of the snow melt surface while operating in the storm operation. Storm operation temporarily preheats the slab to allow faster reaction time to reach the melting temperature when snow is detected.	OFF, 20 to 95°F (-6.5 to 35.0°C) Default = Off	User Installer
MANUAL MELT TIME Select the amount of running time when manually starting the system.	0:30 to 24:00 hours Default = 4:00 hours	User Installer
ADD MELT TIME Select the amount of additional melting time after the Snow/Ice Sensor is dry. This allows low spots on the slab to fully dry before the snow melting system is shut off.	0:00 to 6:00 hours Default = 0:00 hours	Installer
STORM RUN TIME Select the amount of storm run time to pre-heat the slab when advised of a winter storm warning.	0:30 to 24:00 hours Default = 8:00 hours	Installer
SENSITIVITY Select how sensitive Snow/Ice Sensor is to water detection.	Auto, Min, -2, -1, Mid, +1, +2, Max Default = Auto	Installer
WWSD Select the temperature above which the snow melting system is shut off during warm weather. This allows the snow or ice to melt off the slab naturally.	Auto, 32 to 95°F (0.0 to 35.0°C) Default = Auto	Installer
CWCO Select the temperature below which the snow melting system is shut off during extremely cold weather. Below this temperature, the heat loss of the slab exceeds the capacity of the boiler or heating appliance.	Off, -30 to 50°F (-34.5 to 10.0°C) Default = 10°F (-12.0°C)	Installer

Away Menu

At Home

Select at home to allow automatic snow melting operation.

Away

Select away to prevent snow melting operation and save energy.

The screenshot shows a control interface for the 'Away' menu. At the top, a blue header bar contains the word 'Away'. Below this, there are two radio button options: 'At Home' (which is selected, indicated by a blue dot) and 'Away'. At the bottom of the interface, there are two rectangular buttons: 'Back' on the left and 'Help' on the right. Two lines with arrows point from the text descriptions on the left to the 'At Home' and 'Away' radio buttons.

NOTICE

The home/away changes devices system-wide. All thermostats and controls that are grouped together on a tekmarNet system will also change together.

Display Menu

Description	Range	Access
TEMPERATURE UNITS Select Fahrenheit or Celsius temperature units. Conditions: Always available.	°F or °C	User Installer
SCREEN BRIGHTNESS Select the screen brightness. Conditions: Always available.	0 to 100% Default = 75%	User Installer
CLEAN SCREEN The Clean Screen timer locks the screen for 10 seconds allowing the user to wipe the screen with a moist cloth. Do not use solvents to clean the screen. Conditions: Always available.	No, Yes	User Installer

WiFi Menu

NOTICE

Before using the WiFi features of this product, you must accept the Terms of Use, as amended from time to time and available at Watts.com/terms-of-use. If you do not accept these terms, this product can still be used without WiFi features.

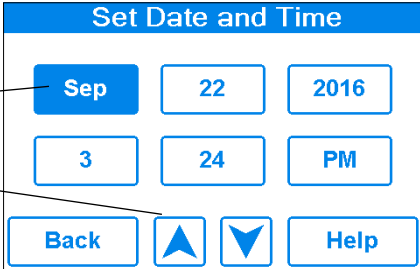

Description	Range	Access
WiFi Enable or disable WiFi connectivity. The help screen displays the following information: <ul style="list-style-type: none"> • IP Address • Subnet Mask • Gateway • MAC Address Conditions: Always available.	Off or On	User Installer
NETWORK SSID Select the WiFi network from the list. Conditions: WiFi is set to On.	List of WiFi Networks	User Installer
ZIP/POSTAL CODE Enter a US ZIP or Canadian postal code. The ZIP/Postal Code is used to provide the location for the weather information. The weather service is available in the USA and Canada only Conditions: WiFi is set to On.	US ZIP format 12345 Canada Postal Code format A1B2C3	User Installer
TIME SOURCE Select to set to the time automatically or manually. Conditions: WiFi is set to On.	Auto, Manual	User Installer

Time Menu

Description	Range	Access
TIME SOURCE Select to set to the time automatically or manually. Auto is only available when WiFi is set to On. Conditions: Always available.	Auto, Manual	User Installer
SET TIME AND DATE Conditions: Time source set to manual. <ul style="list-style-type: none"> • Press box field. • Then adjust with arrow buttons. 	N/A	User Installer
TIME FORMAT Select either 12 or 24 hour format. Conditions: Always available.	12 hr, 24 hr Default = 12 hr	User Installer
TIME ZONE Select the location's time zone. Conditions: Available when Time Source is set to Manual.	Hawaii, Alaska, Pacific, Mountain, Central, Eastern, Atlantic, NFLD, (Newfoundland)	User Installer
DAYLIGHT SAVINGS Set Daylight Savings to On to automatically adjust for time changes in the spring and fall. Conditions: Always available.	Off or On Default = On	User Installer

WiFi and Connectivity Troubleshooting

WiFi Connection Status

Press  > WiFi > WiFi:On >  to view the thermostat connection status.

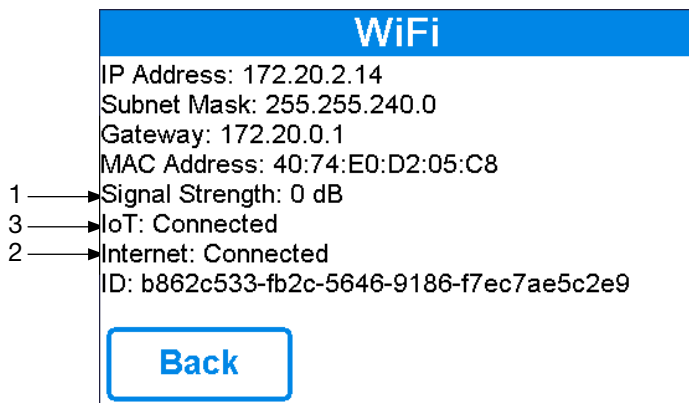

(1) WiFi Signal Strength

- The WiFi signal must measure between 0 and -69 dB to have a reliable connection to the Watts® cloud.
- A WiFi extender is recommended to be installed if the WiFi signal is between -70 to -100 dB.

(2) Internet Connected

- The WiFi information screen will show Internet Connected when the thermostat is connected to the router and there is a connection to the Internet.

(3) IoT Connected

- The thermostat connection status will show IoT Connected when connected to the Watts Cloud and the thermostat is ready to be registered to the app.

If IoT is not connected, please follow these steps:

Check Password

- Double check that you are using the correct WiFi network and password.
- The password is limited to 32 characters, and can include upper and lower case letters, numbers, special characters and spaces. A space counts as a character.
- The thermostat supports WPA2-Personal password security.

Power Off and On

- Power the thermostat off. Next, power the router off, wait 10 seconds, then power on and wait for the Internet status to be on. Then power the thermostat on.

Check Router & Firewall

Consult the router manual or Internet Service Provider (ISP) for assistance with router setup with these configurations:

- The router must provide a 2.4 GHz signal. The thermostat is not compatible with 5 GHz networks.
- The router is using WPA2-Personal security.
- The router has DHCP enabled with enough available addresses for all Internet devices.
- The router firewall is not blocking the outbound UDP or TCP ports: 53, 123, 443, 8883.
- The router firewall is not blocking connections to *.azure-devices.net
- The router firewall is not blocking the thermostat based upon a MAC filter list.

Network Troubleshooting

- tekmar provides free access to a network troubleshooting tool called **RouteThis Helps**.
- Download the app from the App Store or Google Play Store to your mobile device.
- Enter code “TEKM” and click “Network scan”. The app will provide further instructions.

Create a WiFi Hotspot

- If you are unable to connect to the WiFi network, try creating a WiFi Hotspot on your mobile device to bypass the router.
- Apple* iOS WiFi hotspot instructions <https://support.apple.com/en-us/HT204023>
- Android** WiFi hotspot instructions <https://support.google.com/android/answer/9059108>
- If the thermostat displays IoT connected when using the WiFi Hotspot, please contact your Internet Service Provider (ISP) or IT professional for assistance with the router.

* Apple and App Store are trademarks of Apple Inc.

** Google, Android and Google Play are trademarks of Google LLC.

Energy Menu

Amount of time the system has been on in hours per day.

Amount of time the system has been on in hours per month.

Daily Usage	
Mon	0 hrs
Tue	0 hrs
Wed	0 hrs
Thu	0 hrs
Fri	0 hrs
Sat	0 hrs
Sun	0 hrs

[Back](#)
[Monthly Usage](#)
[Help](#)

Monthly Usage			
Jan	0 hrs	Jul	0 hrs
Feb	0 hrs	Aug	3 hrs
Mar	0 hrs	Sep	0 hrs
Apr	0 hrs	Oct	0 hrs
May	0 hrs	Nov	0 hrs
Jun	0 hrs	Dec	0 hrs

[Back](#)
[Daily Usage](#)
[Help](#)

Monitor Menu

Description	Range	Access
MELTING HOURS Records the number of melting hours since the counter was last reset. Conditions: Always available.	0 to 999999 hours	User Installer
HEAT HOURS Records the number of hours the boiler fired or the electric cable heated since the counter was last reset.	0 to 999999 hours	User Installer
HEAT CYCLES Records the number of cycles the boiler turned on or the electric cable heated since the counter was last reset.	0 to 999999 cycles	Installer
SYSTEM PUMP Records the number of hours the system pump has operated since the counter was last reset.	0 to 999999 hours	Installer
SLAB SENSOR HIGH Records the highest measured slab temperature since the counter was last reset. Conditions: Available when Snow/Ice is set to In-slab or Slab Sensor is set to On	-58 to 167°F (-50.0 to 75.0°C)	Installer
SLAB SENSOR LOW Records the lowest measured slab temperature since the counter was last reset. Conditions: Available when Snow/Ice is set to In-slab or Slab Sensor is set to On	-58 to 167°F (-50.0 to 75.0°C)	Installer
OUTDOOR HIGH Records the highest measured outdoor air temperature since the counter was last reset. Conditions: Always available.	-67 to 149°F (-55.0 to 65.0°C)	Installer
OUTDOOR LOW Records the lowest measured outdoor air temperature since the counter was last reset. Conditions: Always available.	-67 to 149°F (-55.0 to 65.0°C)	Installer
RESET ALL? Resets all the counters in the monitor menu at once. Conditions: Always Available.	No, Yes	Installer

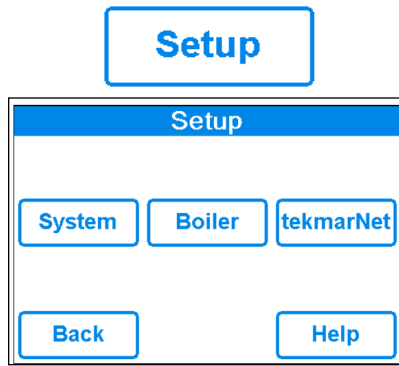

Setup – System Setup Menu

Description	Range	Access
SNOW/ICE SENSOR Select if a Snow/Ice Sensor 090 or 094 “Inslab”, or a Snow Sensor 095 “Aerial” is installed. Conditions: Always available.	None, In-slab, Aerial Default = In-slab	Installer
SLAB SENSOR Select if a Slab Sensor 072 or 073 is installed. Conditions: Available when snow/ice sensor is set to None or Aerial.	Off or On Default = Off	Installer
ECONOMELT EconoMelt allows the user to mechanically remove snow then manually start the system to melt the remaining thin snow layer or ice with an automatic stop when the sensor is dry. Requires snow/ice sensor to be set to in-slab	Off or On Default = Off	Installer
MAX MELT DAYS Limit the amount of melting run time after snow is automatically detected by a Snow/Ice Sensor 090 or 094, or a Snow Sensor 095. Conditions: Always available.	Off, 0.5 to 7 days Default = 3 days	Installer
OUTDOOR SENSOR Select if the outdoor air temperature is measured by the control, by a tekmarNet system or by the Internet weather service. Conditions: Always available.	Control, tekmarNet, Internet Default = Control	Installer

Setup – Boiler Setup Menu

Description	Range	Access
BOILER TYPE Select the type of boiler operated by the control. Enable = Boiler relay turns on the heat source. Control = Call for heat to tekmarNet control. Conditions: Available when the 671 is connected to a tekmarNet system.	Enable, Control	Installer

tekmarNet Menu

Description	Range	Access
<p>ADDRESSING The tekmarNet address of this control. To manually set the address, use the up or down buttons.</p>	Auto, x:01 to bus x:24,	Installer
<p>AUTO ADDRESS The tekmarNet address of this control. Conditions: Addressing is set to Auto</p>	Auto b:01 to b:24 1:01 to 1:24 2:01 to 2:24 3:01 to 3:24	Installer
<p>MANUAL ADDRESS The tekmarNet address of this control when manually assigned Conditions: Addressing is set to Manual</p>	Manual b:01 to b:24 1:01 to 1:24 2:01 to 2:24 3:01 to 3:24	
<p>DEVICE COUNT Provides a count of all the tekmarNet thermostats, setpoint controls and snow melting controls on the tekmarNet System.</p>	1 to 24	Installer
<p>SNOW MELT ZONE Select the snow melting zone that this control operates. Snow zone 1 has the highest priority while snow zone 12 has the lowest priority.</p>	1 to 12	Installer
<p>TRACK ZONE Select to track and record the running hours of snow zone 1 and repeat this run time on this control. This allows snow melting zones without a snow/ice sensor to automatically start.</p>	Off or On	Installer
<p>MELT GROUP A User Switch or Gateway may be used to manually start melting the zone. Set the Melt Group number to the corresponding Setpoint Enable number on the User Switch.</p>	1 to 12	Installer
<p>STORM GROUP A User Switch may be used to manually start storm operation of the snow zone. Set the Melt Group number to the corresponding Setpoint Enable number on the User Switch.</p>	1 to 12	Installer
<p>PRIORITY Select the priority of the snow melting system.</p>	Off, Conditional, Full Default = Off	Installer
<p>AWAY SCENE Select if the control should accept or ignore the away command from a tekmarNet system. Conditions: Always available.</p>	Off or On Default = On	Installer
<p>TN4 SYSTEM PUMP Select if the system pump located on the tekmarNet System Control should operate when the snow melt zone is heating.</p>	Off or On	Installer

Toolbox Menu

Description	Range	Access
ERROR CODE The current error code is displayed. Conditions: Always available.	See Error Code Section	User Installer
ACCESS LEVEL Select the access level of the control. This determines which menus and items are available through the user interface. Conditions: Always available.	User or Installer Default = Installer	User Installer
TYPE 671 Product information. SW: J1288 1.0.0 SVN: XXX Conditions: Always available.	J1288 Last 3 numbers indicate software version	User Installer
LOAD DEFAULTS Select "Yes" to reload the factory defaults on the control. Conditions: Always available.	No, Yes	User Installer

Override Menu

Description	Range	Access
MANUAL OVERRIDE Manually override the normal automatic operation of the control to test the equipment or operate the system at the maximum temperature limits. Auto = Normal operation. Max Heat = Operate hydronic system at maximum heat. Hand = Manual override of each relay output. Purge = Hydronic system purge operates pumps to help bleed air from the system.	Auto, Hand, Max Heat, Purge, Off	User Installer
SYSTEM PUMP Manually turn on the system pump during the HAND Manual Override.	Off or On Default = Off	User Installer
HEAT RELAY Manually turn on the heat relay during the HAND Manual Override.	Off or On Default = Off	User Installer
BOILER ENABLE Manually turn on the boiler during the HAND Manual Override.	Off or On Default = Off	User Installer
HAND DURATION Select the amount of time that the HAND Override is in effect before returning to Automatic operation.	0:10 to 72:00 hours Default = 0:10 hour	User Installer
MAX HEAT DURATION Select the amount of time that Max Heat is in effect before returning to Automatic operation.	0:10 to 72:00 hours Default = 24:00 hour	User Installer
PURGE DURATION Select the amount of time that the Purge is in effect before returning to Automatic operation.	0:10 to 72:00 hours Default = 0:10 hour	User Installer

Sequence of Operation

Snow Melting Overview

A snow melting system can offer a safe, convenient, and cost effective way of removing snow and ice from the snow melting slab and similar surfaces. Safety is increased by activating the snow melting system as soon as the snow falls rather than waiting for mechanical snow removal after snow has accumulated. This eliminates slip hazards and reduces the risk of injury by mechanized snow melting equipment, thereby reducing potential liability costs. The elimination of snow plow equipment and corrosive salts also reduces damage to the slab surface and to the environment. When controlled correctly, snow melting systems can be cost competitive compared to mechanical snow removal.

The snow melting control can operate in one of four different ways:

- Melt** Heats the slab to melt snow or ice. Default is 36°F (2°C)
- Idle** Preheats the slab just below freezing to shorten the time required to melt snow. Default is off.

- Storm** Temporarily preheats the slab just below freezing to shorten the time required to melt snow. Default is off.
- Off** Snow melting system is off
The display shows the control operation in the home screen.

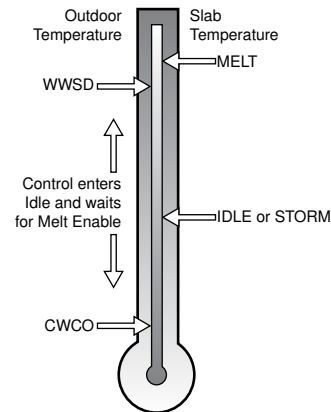

Melt – Automatic Start and Stop

Automatic start and stop operation requires the installation of a Snow/Ice Sensor 090 (65' or 20 m cable) or 094 (208' or 63 m cable). The sensor is installed in-slab level with the melting surface. The control continually monitors the sensor for the presence of moisture and slab temperature conditions in which snow or ice may be present. When moisture is detected, the control shows “Sensor Water Status – Wet” in the Slab Status menu. When the sensor is dry the control shows “Sensor Water Status – Dry”. The control includes a Sensitivity setting in the Temperatures menu that allows the installer to adjust the amount of moisture required to start and stop the melting operation. In areas with low amounts of dust and/or air pollution, the sensitivity may need to be increased. The default sensitivity setting is Auto. This setting allows the control to automatically determine the best suitable sensitivity

setting for the installation.

When moisture is detected and the control is not in WWSID or CWCO or Away, the control will automatically start the snow melting system. As the snow or ice melts and the slab dries off, the sensor also dries off at the same time. When the sensor is dry, the snow melt system automatically shuts off. If there are low spots on the slab surface that dry off slower than the sensor, additional melting run time can be included by adjusting the Additional Melt Time setting in the Temperatures menu.

If the snow melting system is manually stopped, the snow/ice sensor must fully dry before it is able to detect a new snow fall and automatically start the snow melting system.

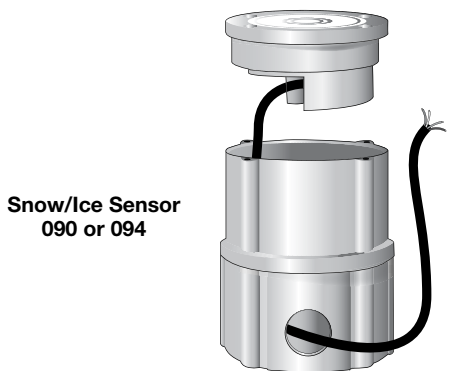

Snow/Ice Sensor
090 or 094

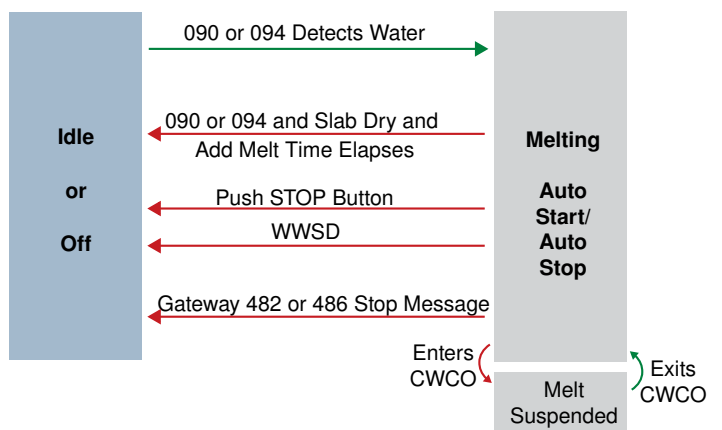

NOTICE

The slab temperature must reach the slab target in order for the system to shut off automatically. The capacity of the heat source must be sized to ensure melting as low as the cold weather cut off. In addition, the heat source maximum temperature setting

must be set to provide the full capacity of the heating appliance. For example, boiler aquastats should be set to 180°F (82°C). Failure to meet these requirements may result in the snow melting system not automatically shutting off when the slab is dry.

Melt – EconoMelt

When a Snow/Ice Sensor 090 or 094 is installed, the installer can choose to select to either automatically or manually start the snow melting system. Selecting EconoMelt to On allows snow removal using a snow plow or shovel. The remaining thin layer of snow or ice that mechanical snow removal methods are unable to remove can be melted using the manual start operation. The snow melting system stops when the sensor is dry. The factory default for EconoMelt is Off.

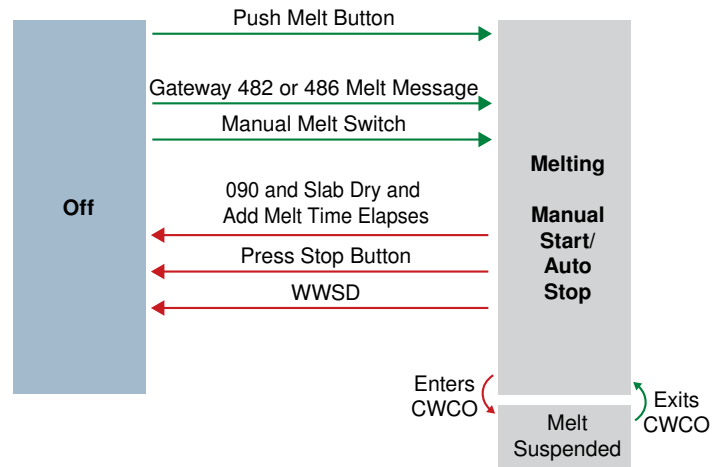

Additional Melting Time

A Snow/Ice Sensor 090 or 094 automatically shuts off the snow melting system when the water sensor is dry. Due to the construction of the slab and the layout of the heating pipe or electrical cable, there may be areas that do not melt completely. The Additional Melt Time setting in the Temperatures menu allows the installer to set addition melting time after the sensor is dry.

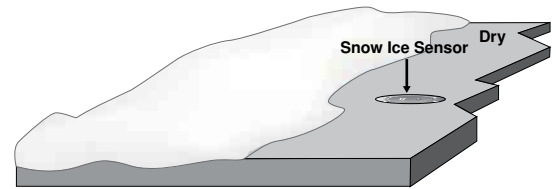

Melt – Automatic Start and Timed Stop

Automatic start with a timed stop operation requires the installation of a Snow Sensor 095. The sensor is aerial mounted on a pole near the melting surface. It is highly recommended to also install a Slab Sensor 072 (20' or 6 m cable) or 073 (40' or 12 m cable) in order to regulate the slab temperature and operate the snow melting system at the highest possible efficiency. The control continually monitors the snow sensor for the presence of moisture and slab temperature conditions in which snow or ice may be present. When moisture is detected, the control will show "Sensor Water Status Wet" in the Slab Status menu. When the sensor is dry the control will show "Sensor Water Status Dry". The control includes a Sensitivity setting in the Temperatures menu that allows the installer to adjust the amount of moisture required to start

and stop the melting operation. In areas with low amounts of dust and/or air pollution, the sensitivity may need to be increased. The default sensitivity setting is Auto. This setting allows the control to automatically determine the best suitable sensitivity setting for the installation.

When moisture is detected and the control is not in WWSD or CWCO or Away, the control automatically starts the snow melting system. The snow melting system operates to heat the slab to the slab target temperature and continues to operate until the time set by the Manual Melt Run Time in the Temperatures menu elapses. If the 095 re-detects water, the timer is restarted to operate for the full run time.

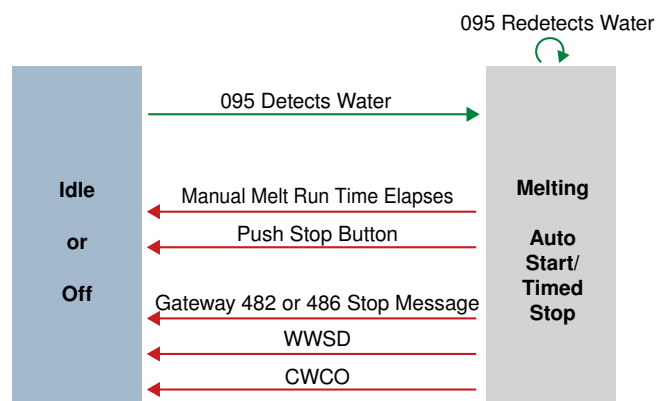

Tandem Snow/Ice Detection

The 671 can be paired together with a 654 to allow two Snow/Ice sensors 090 or 094 or Snow Sensors 095 to be installed for a single zone. This provides full redundancy and increases the snow detection area.

Both sensors are used to detect snow or ice and if either sensor is wet the snow melting zone starts melting. The control continues to operate until both sensors are dry. This allows snow or ice detection over a wider area. In the event of a sensor failure, the control continues to operate normally, giving building maintenance staff time to troubleshoot and replace the faulty sensor if necessary.

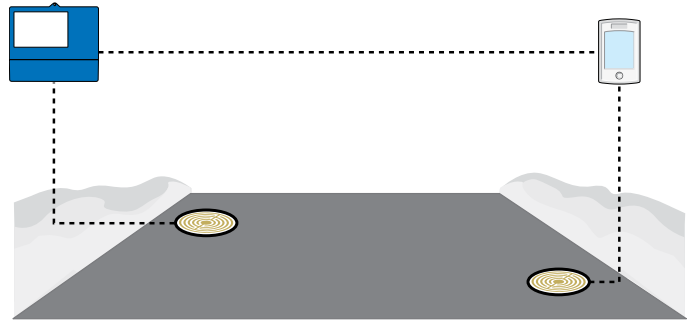

Melt – Manual Start and Timed Stop

The snow melting system can be started manually by one of the three different methods:

- Touch the Melt button on the control display
- Through a Gateway 482 or 486 melt request message
- By manually connecting the Manual Melt and Com wiring terminals 8 and 9 together.

Once manually started and the slab warms up to the slab target,

the snow melting system runs until the time set by the Manual Melt Run Time setting in the Temperatures menu elapses.

If a manual start has been provided and a Snow/Ice Sensor detects water, the control changes from manual melt to automatic operation. The snow melting system runs until the sensor is dry and the Additional Melt Time elapses.

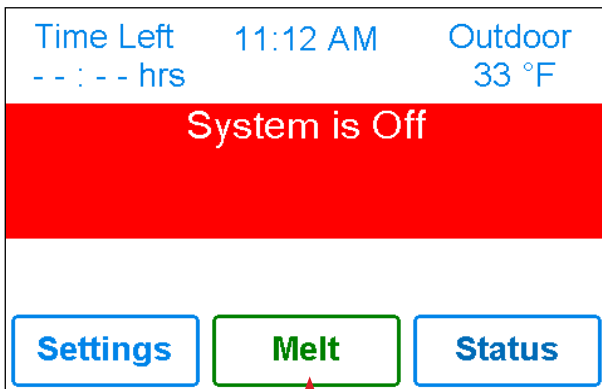

Press Melt button to start melting operation

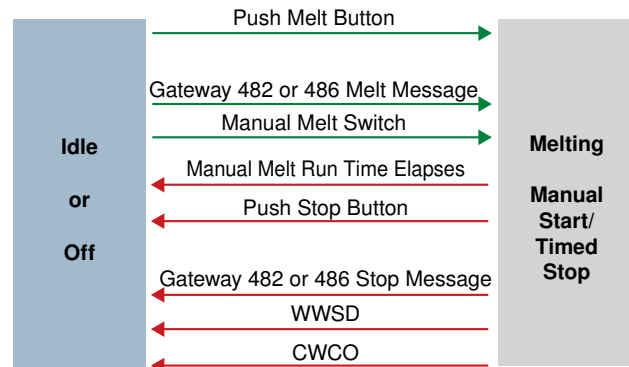

Melt - Tracked Start and Stop

The snow melting system can have multiple zones. Zones have the option to track the melting run time of zone 1. This is useful in cases where zone 1 has an automatic Snow / Ice Sensor installed and the remaining zones do not. This allows zones 2 to 12 to gain the functionality of automatic starting and stopping with only one Snow / Ice sensor installed in the system.

When zone 1 detects snow or ice, it starts melting. Zones with tracking enabled can also start melting unless priority is selected. When the sensor in zone 1 is dry or the Manual Melt Run Time has fully elapsed, it sends a signal to the tracked zones that zone 1 has stopped. Each zone can continue to operate to complete their own Additional Melt Time after which the zone stops heating and returns to the Off or Idle operation. Zones with priority selected start after zone 1 has finished melting and repeat the same run time as zone 1.

Track Melt Start and Stop

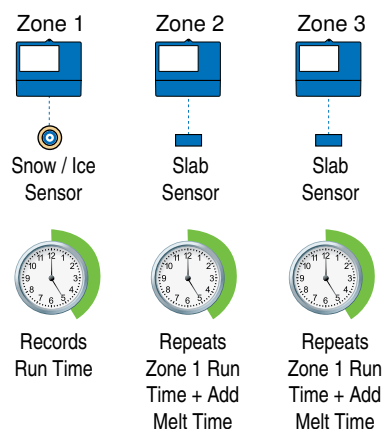

Idle Operation

When the snow melting system starts from a cold temperature, there may be a long time delay before the slab is warm enough to melt snow. This time delay allows snow to accumulate on the slab which is not acceptable in some commercial and institutional applications. To decrease the start-up time, the slab can be pre-heated to maintain a minimum temperature. This is known as the Idle temperature. Idling requires large energy consumption and is generally recommended for institutional and/or commercial installations where safety concerns are paramount. The display shows “System is Idling” when the control is in idle operation.

When designing a snow melting system, an engineer may specify the amount of allowed snow accumulation as the Snow-Free Area Ratio. There are three different levels. A Snow-Free Area Ratio of 1 is defined as a system that melts all snow as it falls with no allowed accumulation. This requires that the Idle temperature be set just below freezing. Examples of these types of applications include:

- Hospital emergency areas
- Helicopter landing pads
- Parking garage ramps

A Snow-Free Area Ratio of 0.5 is defined as a system with partial snow accumulation on the slab but not in all areas.

These types of systems may also use Idling but usually set at a temperature several degrees below freezing to reduce energy consumption. Applications may include:

- Steep residential driveways
- Commercial sidewalks
- Loading docks

A Snow-Free Area Ratio of 0 is defined as a system that allows snow accumulation. These systems operate the snow melting system from a cold start resulting in the lowest energy consumption costs and the longest times to start melting snow. In this case set the Idle to off. This is recommended for most residential applications such as:

- Flat residential driveways
- Patios
- Residential sidewalks

Some systems are designed for keeping a slab surface free of ice rather than free of snow. The most common applications include:

- Car wash bays and aprons
- Aircraft hanger aprons
- Turf conditioning on golf course greens

These systems require the use of Idling at or near freezing throughout the winter and may result in high energy consumption.

Storm Operation

The Storm operation combines the benefits of a fast response time together with lower operating costs. Typically the storm temperature is set below freezing to maximize energy savings.

When the storm operation is manually started, the snow melt system heats the slab up to the melting temperature and completes a melting cycle.

Manual Storm

The storm operation is manually started by a User Switch 480 and 481 or a Gateway 482. The manual storm uses the Storm Group number in the tekmarNet menu.

Setup Procedure



Step 1: Set the 671 Storm Group number from 1 to 12. The default is 12.

Step 2: Set the User Switch or the Gateway to use the corresponding Storm Group number.

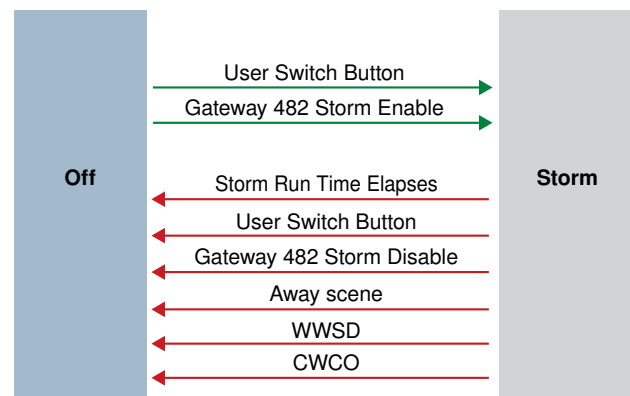
When the User Switch button is pressed, the 671 will enter the Storm Operation. Likewise, activating the Storm Group on the Gateway cause the 671 to enter the Storm Operation.

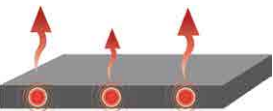

If  forecast

Then  

Slab Temperature Control

Controlling the slab temperature is critical to minimizing the cost of snow melting. This requires that either a Snow/Ice Sensor 090 or 094 or a Slab Sensor 072 or 073 is installed. The Snow/Ice Sensor contains a built-in slab temperature sensor. While the control can operate without a slab sensor installed, operating costs are much higher.

The slab is operated using slab outdoor reset. As the outdoor temperature gets colder, the heat loss of the slab increases. In order to keep the slab surface at a constant temperature while operating, the inner core of the slab must be heated above the melt, idle or storm temperature setting. The amount that the slab inner core temperature is above the melt, idle or storm setting is proportional to the outdoor temperature. Since the slab sensor is installed below the surface of the slab, it is not measuring the true slab surface temperature but rather the inner core temperature. The control automatically compensates for this temperature difference. The Slab item in

the Status menu displays the actual measured temperature, so it is normal to view slab temperatures that exceed the melt, idle, or storm temperature settings.

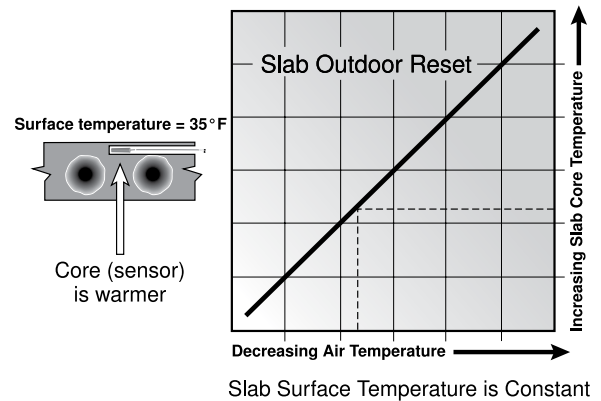

Snow Melt Zones and Priority

Dividing a system into a number of snow melting zones and prioritizing the zone operation reduces the size requirements of the hydronic heating plant or the amperage of the electrical service panel. This results in lower initial capital cost of the snow melting system. The trade off is that some snow melt zones may not be able to melt as soon as the snow fall begins and the user must tolerate snow accumulation on the slab.

The snow melt system using Snow Melting Control 654, 670 and 671 may have up to 12 snow melt zones. Zone 1 has the highest priority and zone 12 has the lowest. The priority setting in the tekmarNet® menu allows the installer to select the level of zone priority for the entire snow melt system. Changing the priority setting on one control will update on all other snow melt controls at the same time. The zone priority has 3 setting levels. There is some risk that lower priority zones may ice up when they are shut off by the higher priority zone. For example, if a high priority zone should finish melting and allow a lower priority zone to start melting, and then a new snow fall occurs, the high priority zone will shut off the lower priority zones. This may

potentially allow the lower priority zones to ice over. The limitations of zoning and using priority must be carefully considered and discussed with the building owners and occupants when designing the snow melting system.

Priority does not apply when the application mode is set to Boiler. In this mode, the boiler is dedicated to a single snow melting zone so priority is no longer applicable.

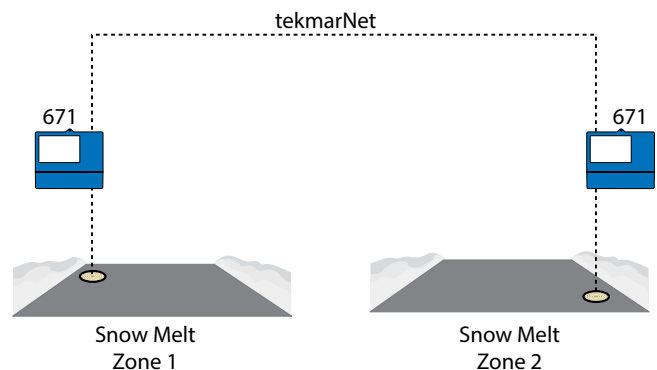

Hydronic Priority Levels

Priority = None

All zones have the same priority and can operate at the same time. This setting is recommended when the boiler plant capacity is sized larger than the heat loss of all zones at design conditions.

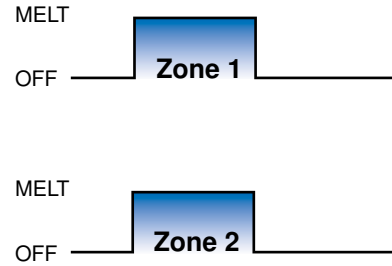

Priority = Conditional

The zone with the lower priority starts melting when the zone with higher priority is warm enough to melt snow or ice. This setting is recommended when the boiler plant capacity is sized to be larger than the heat loss of each zone with some extra capacity.

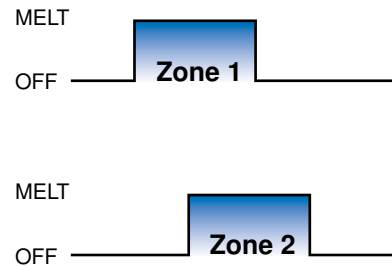

Priority = Full

The zone with the lower priority starts melting once the zone with higher priority has finished melting all snow or ice from the slab. This setting is recommended when the boiler plant capacity is sized to be the same as the heat loss of each zone at design conditions.

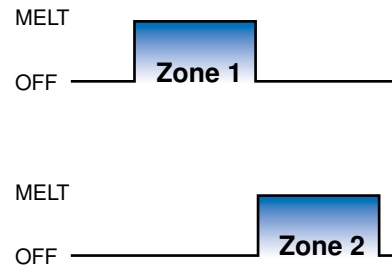

Warm Weather Shut Down

During warm weather, the slab is warm enough to naturally melt snow or ice. The control has a Warm Weather Shut Down (WWSD) setting in the Temperatures menu that prevents the control from entering Melt, Idle or Storm operation in order to conserve energy. The control shows, “System is Off – Warm Weather Shut Down” on the display when WWSD is in effect.

Automatic (Auto)

The control enters WWSD when both the slab temperature and the outdoor temperature exceed the Melting Setpoint temperature setting by more than 2°F (1°C).

Manual WWSD

The control enters WWSD when the outdoor air temperature exceeds the WWSD setting by 1°F (0.5°C) and when the slab temperature exceeds 34°F (1°C). The control exits WWSD when the outdoor air temperature falls 1°F (0.5°C) below the WWSD setting or if the slab temperature falls below 34°F (1°C). This allows the Melting Setpoint setting to be set higher than the WWSD. This is useful when high slab temperatures are required to melt the snow or ice. An example of this are installations using paving bricks on top of sand and concrete layers.

Cold Weather Cut Off

Maintaining the melting or idling setpoint temperature during extremely cold temperatures is not only expensive but may be impossible if the heat loss of the slab exceeds the input capacity of the heating plant or electric cable. The control turns the snow melting system off when the outdoor air temperature drops below the Cold Weather Cut Off (CWCO) temperature. This is a safety and energy saving measure. The control shows, “System is Off – Cold Weather Cut Off” on

the display when CWCO is in effect. When the temperature reaches the CWCO setting in an actively melting system with an 090 or 094, melting is suspended until the outdoor temperature rises above the CWCO setting at which time melting is resumed. If an 090 or 094 is not installed, melting is stopped when CWCO is in effect and melting does not resume when the temperature rises above the CWCO setting.

Time Clock

The control has a built-in time clock that can be set manually. A battery-less backup allows the control to keep time for up to 4 hours without power. The time clock supports automatic adjustment for Daylight Saving Time (DST) once the day,

month and year are entered. Use the Time menu to set the correct time, day, month and year.

Away Operation

While on vacation and away from a building, it may not be necessary to operate the snow melting system. The away feature allows the user to shut off the snow melting system to maximize energy savings. The Away feature can be activated through the:

- Away menu
- tekmarNet User Switch 480 or 481
- tekmarNet Gateway 482 or 486

tekmarNet Scene Operation

The tekmarNet system supports up to 8 scenes.

The 671 supports tekmarNet scenes 1 (normal operation) and 2 (away).

During tekmarNet scenes 3 through 8, the 671 remains in scene 1 (normal operation).

Pulse Width Modulation Zone Operation

The control operates the system pump to operate continuously during melt, idle and storm operation. The boiler relays and heat pumps relays operate on a 20-minute pulse width modulation cycle. The relay on time is determined by the calculated slab target and by the measured slab temperature reading. As the slab temperature reaches the slab target, the on time per cycle of the relay is reduced to prevent the slab temperature from overshooting. If no slab sensor is installed the heat relay remains on 100% of the time until the Melt circle has completed.

When connected to a tekmarNet system, the 671 can operate a boiler (Boiler Type set to Enable) or it can call for heat from the tekmarNet boiler control (Boiler Type set to Control)

Relay operation:

- System pump — operates continuously during melting, idling or storm
- Heat relay — cycles on/off using Pulse Width Modulation to control the slab temperature
- Boiler — cycles on/off using Pulse Width Modulation to control the slab temperature

Outdoor Sensor

An outdoor air temperature is required for proper operation. The control has the option to measure an outdoor air sensor or the outdoor temperature can be provided through the tekmarNet

system or through the Internet weather service. This is selected by the Outdoor Sensor setting in the System Setup menu.

Exercising

The control operates the system pump and heat relay every 3 days to prevent pump and valve seizure.

Post Purge

The boiler or heat source is shut off and the snow melting system continues to operate for 20 seconds to post purge heat from the boiler to the load.

Troubleshooting

It is recommended to complete all wiring to ensure trouble free operation. Should an error occur, simply follow these steps:



1. **Find:** If the control shows the Warning Symbol  on the screen, it is indicating a problem on the system.
2. **Identify:** Press the Warning Symbol to view the error code.
3. **Solve:** Use the chart below to match the error code to the one on the control. Use the description to solve the problem.

Error Messages (1 of 2)

Description
TEMPERATURE MENU MEMORY ERROR A memory error occurred and the control reloaded the factory default settings. The control stops operation until all settings in the Setpoints menu are checked. To clear the error, set the access level to Installer and check all settings in the Temp menu.
SYSTEM SETUP MENU MEMORY ERROR A memory error occurred and the control reloaded the factory default settings. The control stops operation until all settings in the System Setup menu are checked. To clear the error, set the access level to Installer and check all settings in the System Setup menu.
BOILER SETUP MENU MEMORY ERROR A memory error occurred and the control reloaded the factory default settings. The control stops operation until all settings in the Boiler Setup menu are checked. To clear the error, set the access level to Installer and check all settings in the Boiler Setup menu.
tekmarNet MENU MEMORY ERROR A memory error occurred and the control reloaded the factory default settings. The control continues operation as normal. To clear the error, set the access level to Installer and check all settings in the tekmarNet menu.
WiFi MENU MEMORY ERROR A memory error occurred and the control reloaded the factory default settings. The control continues operation as normal. To clear the error, set the access level to Installer and check all settings in the WiFi menu.
MAX MELT DAYS ERROR The control has operated in melting for the time set by the Maximum Melt Days setting. This error is usually created when there is a mechanical system failure resulting in the snow melt slab not heating correctly. Clear the error message by touching the Reset button while viewing the error message.
tekmarNet Communications Error The tekmarNet communication bus has either an open or a short circuit. The result is that there are no communications. The error clears automatically once the wiring fault has been corrected. To force the error to clear while allowing a short or open circuit to continue, touch the Reset key.
ADDRESS TAKEN ERROR Two devices have been manually set to the same address. The device continues to operate with this error but does not communicate with the tekmarNet system. To clear this error, select an unused tekmarNet address or select automatic addressing.
SNOW ZONE TAKEN ERROR Two snow melting controls have been manually set to the same snow zone number. The control continues to operate with this error. To clear this error, select an unused snow zone number.
SYSTEM CONTROL LOST ERROR The thermostat can no longer communicate to the tekmarNet system control. Check for open or short circuits in the tekmarNet communication wiring. The error automatically clears once the tekmarNet system control has been detected. If the tekmarNet system control was intentionally removed from the system, press the Reset button.
TANDEM SNOW/ICE SENSOR ERROR There are two Snow / Ice Sensors installed in the zone and the tandem snow melting control 654 sensor has a problem. Locate the other snow melting control and navigate to the Toolbox menu to determine and correct the problem. The control continues to operate with this error. Press the Reset button to clear the error.
DEVICE LIMIT ERROR More than 24 devices have been connected to the tekmarNet communication bus. To clear the error, remove and relocate devices to other available buses until the device count is 24 or less.

Error Messages (2 of 2)

Description
OUTDOOR SENSOR OPEN CIRCUIT ERROR The control is unable to read the Outdoor Sensor 070. The control continues to operate and assumes an outdoor temperature of 32°F (0°C). Check for wiring faults and it may be necessary to replace the sensor. Once the error has been corrected, the error message automatically clears.
OUTDOOR SENSOR SHORT CIRCUIT ERROR The control is unable to read the Outdoor Sensor 070. The control continues to operate and assumes an outdoor temperature of 32°F (0°C). Check for wiring faults and it may be necessary to replace the sensor. Once the error has been corrected, the error message automatically clears.
SLAB SENSOR OPEN CIRCUIT The control is unable to read the Slab Sensor 072 or 073. Check for wiring faults and it may be necessary to replace the slab sensor. Once the error has been corrected, the error message automatically clears.
SLAB SENSOR SHORT CIRCUIT The control is unable to read the Slab Sensor 072 or 073. Check the wire for faults and it may be necessary to replace the slab sensor. Once the error has been corrected, the error message automatically clears.
SNOW SENSOR YELLOW WIRE OPEN CIRCUIT The control is unable to read the yellow wire connected to the Snow/Ice Sensor 090 or 094 or the Snow Sensor 095. Automatic operation is disabled but manual start is still available. Check the snow/ice sensor yellow and black wires and any wire splices for faults. It may be necessary to replace the sensor. Once the error has been corrected, the error message automatically clears.
SNOW SENSOR BLUE WIRE OPEN CIRCUIT ERROR Due to an open circuit, the control is unable to read the blue wire connected to the Snow/Ice Sensor 090 or 094, or the Snow Sensor 095 on terminals 2 and 3. The control can no longer automatically detect snow or ice, but manual start of the snow melting system is still available. Check the snow/ice sensor or snow sensor blue and black wires and any wire splices for open circuits according to the sensor installation manual. It may be necessary to replace the sensor. Once the error has been corrected, the error message automatically clears.
SNOW SENSOR BROWN WIRE SHORT CIRCUIT ERROR The control is unable to read the brown wire connected to the Snow/Ice Sensor 090 or 094. Check the snow/ice sensor brown and black wires for faults. It may be necessary to replace the sensor. Once the error has been corrected, the error message automatically clears.
SNOW SENSOR BROWN WIRE OPEN CIRCUIT ERROR Due to an open circuit, the control is unable to read the brown wire connected to the Snow/Ice Sensor 090 or 094 on terminals 2 and 5. Idling and Storm is disabled and energy saving features such as Warm Weather Shut Down (WWSD) and Cold Weather Cut Off (CWCO) are operated using the outdoor temperature only. Check the snow/ice sensor brown and black wires for open circuits according to the sensor installation manual. It may be necessary to replace the sensor. Once the error has been corrected, the error message automatically clears.
SNOW/ICE SENSOR ERROR The control is unable to properly detect the Snow/Ice Sensor 090 or 094 on terminals 1, 2, 3, 4 and 5. The control can no longer automatically detect snow or ice, but manual start of the snow melting system is still available. Check the snow/ice sensor brown, yellow, red and black wires according to the sensor installation manual. It is important to check any cable splices for loose wiring connections. It may be necessary to replace the sensor. Once the error has been corrected, the error message automatically clears.
SNOW SENSOR ERROR The control is unable to properly detect the Snow Sensor 095 on terminals 1, 2, 3, and 4. The control can no longer automatically detect snow but manual start of the snow melting system is still available. Check the snow sensor yellow, red and black wires according to the sensor installation manual. It may be necessary to replace the sensor. Once the error has been corrected, the error message automatically clears.

Frequently Asked Questions

Symptom	Look For...	Corrective Action
Touchscreen is off	Power to control	Use electrical meter to measure 115 V (ac) voltage on input power L and N terminals.
System pump always on	Display shows Idle	Idle operation requires that the system pump operate continuously while below the melting temperature setting.
Blue short	Dirt or salt on snow/ice sensor	The snow/ice sensor requires regular cleaning. Avoid using road salt on the snow melting slab.
Slab is above melt temperature	Slab Target	The slab is heated to the slab target.
System running with no snow	System is Idling	Idling heats the slab when the temperature falls below the Idle temperature.
	System is Melting	During cold weather cut off (CWCO), the system is shut off. If it shuts off during a melt cycle, the system resumes melting once the outdoor temperature is above CWCO.
	Remaining Run Time	System manually started.
	Slab and Slab Target	The slab must reach the slab target temperature in order for the system to shut off. Lower the cold weather cut off (CWCO) or increase the boiler aquastat setting.
Snow on slab but system did not start	System is Off	System has been manually stopped and the automatic snow/ice sensor never dried, thereby preventing the system from automatically starting.
Cannot register device	Check WiFi signal strength	May need to move control or router location.

Technical Data

WiFi Snow Melting Control 671 <i>Pulse Width Modulation</i>	
Literature	Submittal, Installation and Operating Manual, Application Manual, User Manual, Job Record, Watts Home Manual
Control	Microprocessor control. This is not a safety (limit) control.
Packaged weight	4.3 lb. (1960 g)
Dimensions	6 ⁵ / ₈ " H x 7 ⁹ / ₁₆ " W x 2 ¹³ / ₁₆ " D (170 x 193 x 72 mm)
Display	3.5", color touchscreen
Enclosure	Blue PVC plastic, NEMA type 1
Approvals	CSA C US, meets class B: ICES & FCC Part 15
Ambient conditions	-4 to 122°F (-20 to 50°C), < 90% RH non-condensing, outdoor use permitted when used in NEMA 3 enclosure
Power supply	115 V (ac) ±10%, 60 Hz, 20 VA
Relays	230 V (ac), 5 A, 1/3 hp
Manual melt call	Short or 0 - 32 V(ac)
Communications	WiFi 802.11n, 2.4 GHz, WPA2 encryption
Mobile app	Apple iOS 12 or higher, Android 10 or higher
Sensors	NTC thermistor, 10 kΩ @ 77°F (25°C ±0.2°C) β=3892
-Included	Outdoor Sensor 070
-Optional	tekmar type: 072, 073, 087, 090, 094, 095

Limited Warranty and Product Return Procedure

Limited Warranty *The liability of tekmar under this warranty is limited. The Purchaser, by taking receipt of any tekmar product ("Product"), acknowledges the terms of the Limited Warranty in effect at the time of such Product sale and acknowledges that it has read and understands same.*

The tekmar Limited Warranty to the Purchaser on the Products sold hereunder is a manufacturer's pass-through warranty which the Purchaser is authorized to pass through to its customers. Under the Limited Warranty, each tekmar Product is warranted against defects in workmanship and materials if the Product is installed and used in compliance with tekmar's instructions, ordinary wear and tear excepted. The pass-through warranty period is for a period of twenty-four (24) months from the production date if the Product is not installed during that period, or twelve (12) months from the documented date of installation if installed within twenty-four (24) months from the production date.

The liability of tekmar under the Limited Warranty shall be limited to, at tekmar's sole discretion: the cost of parts and labor provided by tekmar to repair defects in materials and / or workmanship of the defective product; or to the exchange of the defective product for a warranty replacement product; or to the granting of credit limited to the original cost of the defective product, and such repair, exchange or credit shall be the sole remedy available from tekmar, and, without limiting the foregoing in any way, tekmar is not responsible, in contract, tort or strict product liability, for any other losses, costs, expenses, inconveniences, or damages, whether direct, indirect, special, secondary, incidental or consequential, arising from ownership or use of the product, or from defects in workmanship or materials, including any liability for fundamental breach of contract.

The pass-through Limited Warranty applies only to those defective Products returned to tekmar during the warranty period. This Limited Warranty does not cover the cost of the parts or labor to remove or transport the defective Product, or to reinstall the repaired or replacement Product, all such costs and expenses being subject to Purchaser's agreement and warranty with its customers.

Any representations or warranties about the Products made by Purchaser to its customers which are different from or in excess of the tekmar Limited Warranty are the Purchaser's sole responsibility and obligation. Purchaser shall indemnify and

hold tekmar harmless from and against any and all claims, liabilities and damages of any kind or nature which arise out of or are related to any such representations or warranties by Purchaser to its customers.

The pass-through Limited Warranty does not apply if the returned Product has been damaged by negligence by persons other than tekmar, accident, fire, Act of God, abuse or misuse; or has been damaged by modifications, alterations or attachments made subsequent to purchase which have not been authorized by tekmar; or if the Product was not installed in compliance with tekmar's instructions and / or the local codes and ordinances; or if due to defective installation of the Product; or if the Product was not used in compliance with tekmar's instructions.

THIS WARRANTY IS IN LIEU OF ALL OTHER WARRANTIES, EXPRESS OR IMPLIED, WHICH THE GOVERNING LAW ALLOWS PARTIES TO CONTRACTUALLY EXCLUDE, INCLUDING, WITHOUT LIMITATION, IMPLIED WARRANTIES OF MERCHANTABILITY AND FITNESS FOR A PARTICULAR PURPOSE, DURABILITY OR DESCRIPTION OF THE PRODUCT, ITS NON-INFRINGEMENT OF ANY RELEVANT PATENTS OR TRADEMARKS, AND ITS COMPLIANCE WITH OR NON-VIOLATION OF ANY APPLICABLE ENVIRONMENTAL, HEALTH OR SAFETY LEGISLATION; THE TERM OF ANY OTHER WARRANTY NOT HEREBY CONTRACTUALLY EXCLUDED IS LIMITED SUCH THAT IT SHALL NOT EXTEND BEYOND TWENTY-FOUR (24) MONTHS FROM THE PRODUCTION DATE, TO THE EXTENT THAT SUCH LIMITATION IS ALLOWED BY THE GOVERNING LAW.

Product Warranty Return Procedure All Products that are believed to have defects in workmanship or materials must be returned, together with a written description of the defect, to the tekmar Representative assigned to the territory in which such Product is located. If tekmar receives an inquiry from someone other than a tekmar Representative, including an inquiry from Purchaser (if not a tekmar Representative) or Purchaser's customers, regarding a potential warranty claim, tekmar's sole obligation shall be to provide the address and other contact information regarding the appropriate Representative.

Need help? Go to our website or contact us.

tekmarControls.com | tekmar.customerservice@wattswater.com | 1-800-438-3903

tekmar[®]

A WATTS Brand