

Operations and Maintenance Manual

Total Residual Oxidant Monitor for Use in Hazardous Environments

Model SSR-Ex 28037



⚠ WARNING



Read this Manual **BEFORE** using this equipment.

Failure to read and follow all safety and use information can result in death, serious personal injury, property damage, or damage to the equipment.



Keep this Manual for future reference.

Table of Contents

1.0 Safety.....	3	6.0 Maintenance.....	15
1.1 Understanding Safety Information.....	3	6.1 Calibration	15
2.0 Overview	3	6.2 Cuvette Replacement	16
2.1 Specifications	4	6.3 T-Strainer Cleaning	16
2.2 Unpacking and Inspection of the Instrument and Accessories	5	6.4 Adjusting the Pressure Regulator.....	16
2.3 Instrument Labels	5	6.5 Installing New Reagent in the SSR-EX.....	16
3.0 Components Listing	5	6.6 Replacing the Peristaltic Sample Pump Head.....	16
3.1 Electronics Compartment	5	6.7 Instrument Storage	16
3.2 Electrical Enclosure.....	5	7.0 Diagnostic/Troubleshooting Chart.....	17
3.3 User Connections.....	5	8.0 Error/Alarm Messages and Suggested Actions	17
3.4 Wet Section of Enclosure Fittings and Items Listing.....	6	9.0 Technical and Customer Assistance	17
3.5 The Air Sentinel™ II Controller (Factory Installed).....	6	10.0 Spare Parts Listing	17
3.6 The Air Dryer/Filter.....	6	11.0 Limited Warranty	20
4.0 Installation	6		
4.1 Mounting and Site Selection	6		
4.2 Plumbing and Air Connections	7		
4.3 Electrical Connections	7		
4.3.1 Low Voltage Connections	8		
4.3.1.1 Relays.....	8		
4.3.1.2 4-20 mA Analog Output.....	8		
4.3.1.3 Modbus	8		
4.3.1.4 RMT	8		
4.3.1.5 Securing the Glands - Low Voltage.....	8		
4.3.2 Mains Power Connections	8		
4.3.2.1 Securing the Glands - Mains Power.....	8		
4.4 Hardware Control	8		
4.5 Modbus Control.....	9		
4.6 Securing the Electrical Enclosure.....	10		
5.0 Configuration - General Process.....	11		
5.1 Instrument Commissioning and Start-Up.....	11		
5.2 Configuring the SSR-EX	11		
5.2.1 Menu Selection Options.....	12		
5.2.1.1 Main Menu.....	12		
5.2.1.2 Config Menu	12		
5.2.1.3 Analog Output Menu.....	13		
5.2.1.4 Modbus Menu	13		
5.2.1.5 Alarms Menu.....	13		
5.2.1.6 Units Menu	13		
5.2.1.7 Average Menu.....	13		
5.2.1.8 Backlight Menu	13		
5.2.1.9 Cycle Time Menu.....	14		
5.2.1.10 Contact Period Menu.....	14		
5.2.1.11 Standby Pulse Menu.....	14		
5.2.1.12 Restore Defaults Menu.....	14		
5.2.1.13 Restore Factory Cal Menu	14		
5.2.1.14 About Device Menu	14		
5.3 System Start-Up.....	15		
5.3.1 Flush Water Sample Line	15		
5.3.2 Prepare Reagents	15		
5.3.3 Remote Start	15		
5.4 Typical Cycle.....	15		
5.5 Observe Operation	15		

Table of Figures

Figure 1 - Instrument Overview.....	3
Figure 2 - Instrument with Electronics Compartment Open	5
Figure 3 - Close-up of Electrical Compartment.....	5
Figure 4 - Low Voltage Connections.....	5
Figure 5 - Wet Chemistry Area of Enclosure	6
Figure 6 - Utility Connections.....	6
Figure 7 - Air/Dryer Filter	6
Figure 8 - Overall Mounting Dimensions of the Instrument.....	6
Figure 9 - Compression Fitting	7
Figure 10 - Utility Connections.....	7
Figure 11 - Low Voltage Connections.....	8
Figure 12 - Main Screen	11
Figure 13 - Pressure regulator and T-strainer.....	15

1.0 Safety

1.1 Understanding Safety Information

This manual contains safety and use instructions that must be followed during the installation, commissioning, operation, care and maintenance, and service of the SSR-Ex. All responsible personnel must read this manual prior to working with this instrument and should familiarize themselves with the following safety symbols, signals, and pictorials.



The safety alert symbol is shown alone or used with a signal word (DANGER, WARNING or CAUTION), a pictorial and/ or a safety message to alert you to hazards.

When you see this symbol alone or with a signal word on this instrument or in this manual, be alert to the potential for death or serious personal injury.

Safety signal words have the following meaning:

⚠ WARNING	Identifies hazards which, if not avoided, could result in death or serious injury.
⚠ CAUTION	Identifies hazards which, if not avoided, will result in minor or moderate injury.
NOTICE	Identifies practices, actions or failure to act which will result in property damage or damage to the equipment.

Pictorials used on the equipment and in this Manual have the following meanings:

	This pictorial alerts you to the need to read the Manual.
	This pictorial alerts you to electricity, electrocution and shock hazards.

2.0 Overview

This instrument has been specifically designed for TRO measurement and to operate in hazardous atmospheres meeting the IECEx and ATEX ratings as stated in the specifications. The instrument uses an IECEx approved purge/ pressurization controller called the Air Sentinel II.

Please refer to the companion manual Cat. No. 100038B for all information on:

- Operation of the Air Sentinel II
- Electrical Power Connections
- Purge Air Connection



Figure 1 - Instrument Overview

This instrument is sectioned such that all the electrical or powered devices are in the upper, purged section of the enclosure, while the lower (wetted parts) section contains no power at all and can be operated and maintained in a safe condition even with the main enclosure door open. Refer to Figure 2.

The SSR-Ex has been designed to meet the design criteria specified by Standard Methods for the Examination of Water and Wastewater (21th Edition) Method 4500-Cl G. DPD Colorimetric Method.

The SSR-Ex uses a 515nm LED as the measurement light source.

Every effort has been made to ensure the accuracy of this manual. Due to the continuous development and improvement of all instrumentation, there may be slight differences between this manual and the instrument received.

2.1 Specifications

Measurement Range	0.00 – 15.00 mg/l (PPM)
Accuracy	±10% of reading or ±0.03 mg/l (PPM) whichever is greater for range of 0 - 15.0 mg/l (PPM)
Resolution	0.01 mg/l (PPM)
Cycle Time	Adjustable; 45 seconds to 10 minutes (600 seconds)
Display	3.5" Color Graphic
Alarms	Two programmable, 120 - 240 VAC 2A, Form C Relay
Analog Output	Powered 4 - 20 mA, 1000Ω drive, isolated
Communications Port	Bi-directional RS-485 with Modbus
Water Pressure	Integral pressure regulator, maximum pressure 3 bar (45 PSI.)
Flow Rate to Waste	Maximum waste flow rate from the drain is 150 ml/min
Operating Temperature	0°C – 55°C (32°F – 131°F)
Wetted Materials	Polyethylene, Borosilicate Glass, Generic Viton™* Alternative (FKM), Polypropylene, 316 Stainless Steel, Acetal, EPDM, Silicone, Modified PPO, Thermoplastic Elastomer
Sample Temperature Range	0°C – 55°C (32°F – 131°F)
Power Supply	100 to 230VAC, 47 - 63 Hz, 240VA
Insulation Rating	Double Insulated, Pollution Degree 2, Overvoltage Category II
Enclosure	Powder coated steel with windows. IP55 rating
Environmental Conditions	Altitude up to 2000 meters Up to 95% RH (non-condensing)
IECEx Hazloc Rating	II 2G Ex pxb IIC T4 Gb 0°C ≤ Ta ≤ 55°C
Compressed Air Requirements	Water and oil-free, Particles <5u, ISA Grade Hydrocarbon Free. Full time clean dry air at 5.5 - 7 bar (80 - 101.5 PSI) @ 35 SLPM (1.2 SCFM) @ 20oC (68oF) Max
Regulatory Compliance And Certifications	IECEX, ATEX, DNVGL-CG-0339, tested to USCG 46 CFR Part 162 subsection 162.060-30
Shipping Weight	27.2 kg (60 lbs.)
Shipping Dimensions	93 cm X 62 cm X 32 cm (36½" X 24½" X 12½")

*Viton™ is a trademark of The Chemours Company FC, LLC

2.2 Unpacking and Inspection of the Instrument and Accessories

The table below indicates the items included in the shipment.

Item	Quantity
SSR-Ex Monitor Includes - Factory installed Air Sentinel II	1
Owner's Manual	1
Air/Filter Dryer Assembly	1

***Please note: Reagents are not included and must be purchased separately. The SSR-Ex will not function without reagent.**

Remove the instrument from the shipping crate. Carefully inspect all items to ensure that no visible damage has occurred during shipment. If damage is evident contact the delivery company and your supplier. If the items received do not match the order, please immediately contact the local distributor or the HF scientific Customer Service Department.

2.3 Instrument Labels

The following labels should be applied to the outside of the enclosure.

Location	Location	Label
Serial number, manufacturer, part number, power rating, CE & UL marking	Side of Unit	
Warning and informational	Inside Front of Electrical Panel Enclosure	<p>WARNING PRESSURIZED ENCLOSURE</p> <p>Electrical Compartment shall not be opened unless all power has been removed!</p> <p>Minimum Over Pressure: ≥ 0.6 Millibar Maximum Over Pressure: 4 Millibar Minimum Purge Flow Rate: 35 SLPM Minimum Purging Duration: 3 Minutes Maximum Leakage Rate: 45 LPM</p>
Warning and informational	Front of Unit	<p>WARNING</p> <p>Potential Electrostatic Charge Hazard. See Operating Instruction.</p>
Informational	Front of Unit	

3.0 Components Listing

3.1 Electronics Compartment

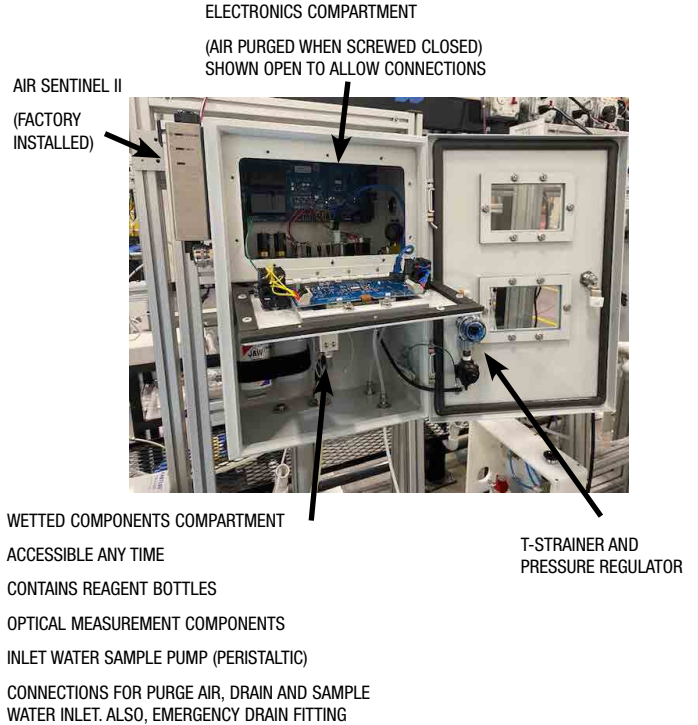

Figure 2 - Instrument with Electronics Compartment Open

3.2 Electrical Enclosure

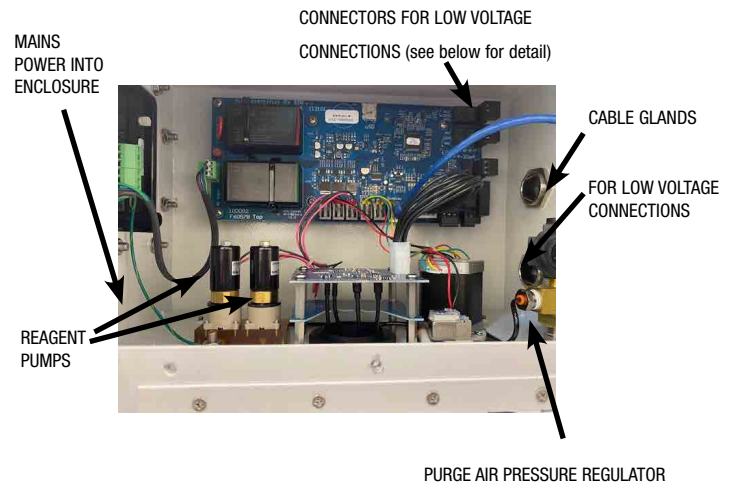

Figure 3 - Close-up of Electrical Compartment

3.3 User Connections

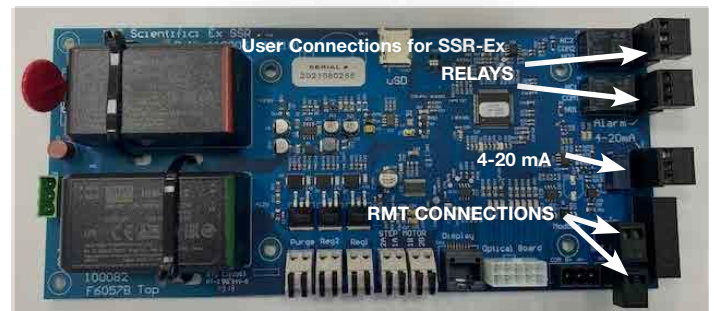

Figure 4 - Low Voltage Connection

3.4 Wet Section of Enclosure Fittings and Items Listing

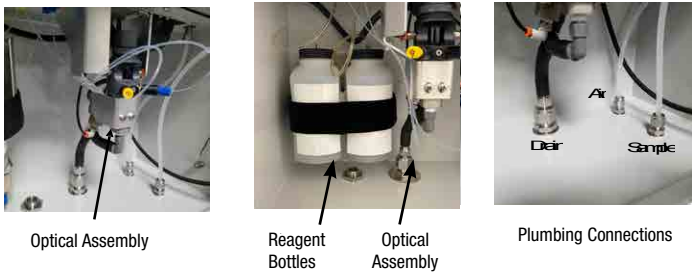

Figure 5 - Wet Chemistry Area of Enclosure

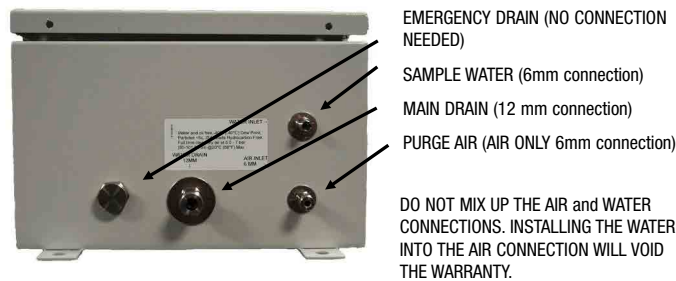

Figure 6 - Utility Connections

3.5 The Air Sentinel II Controller (Factory Installed)

The SSR-Ex will not function without proper air purging of the enclosure. The Air Sentinel II Controller governs the power. Reference Section 2.1 Electronics Compartment, Figure 2 - Instrument with Electronics Compartment Open.

3.6 The Air Dryer/Filter

For proper operation dry clean air must be supplied to the SSR-Ex at pressures between 5.5 and 7 bar (80 to 101.5 PSI). The dryer comes with fittings suitable for use with 6mm tubing, if using the supplied fittings for installation ensure that a proper thread sealant is used.



Figure 7 - Air/Dryer Filter

4.0 Installation

4.1 Mounting and Site Selection

The instrument is designed for wall mounting. Choose a location that is easily accessible for operation and service. It is recommended that the display window is about eye level. Consideration must be made for the plumbing, air, and electrical conduit connections. The overall mounting dimensions of the instrument are shown in Figure 8 - Overall Mounting Dimensions of the Instrument.

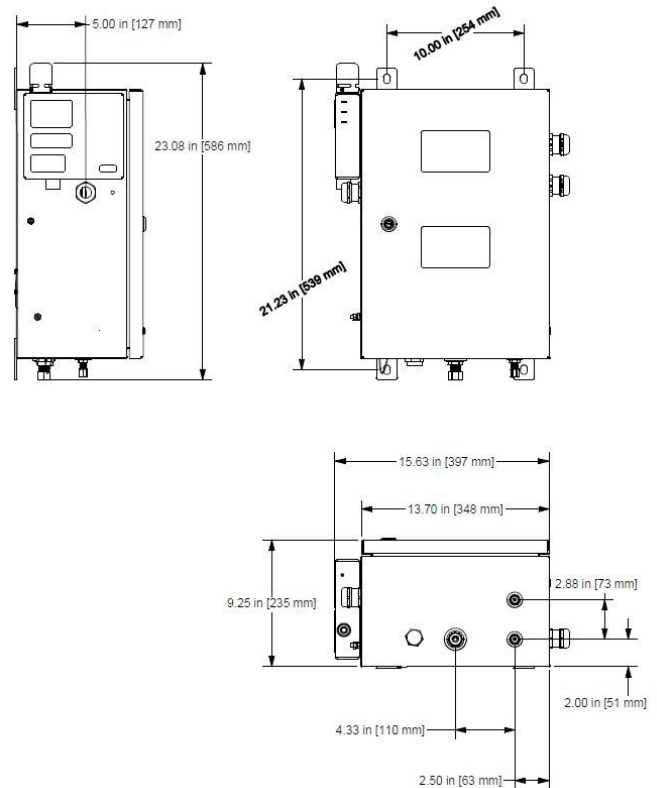

Figure 8 - Overall Mounting Dimensions of the Instrument

Be sure that the instrument is mounted as close as possible to the sampling point to ensure a quick response time (recommended installation is within 2-3 meters (6-10 ft) of the sampling point).

Mounting bolt size should not exceed the size of provided mounting bolt location. Mounting hardware must be rated to support the instrument operation weight of 60 lbs. Mounting hardware provided by others.

4.2 Plumbing and Air Connections

⚠ WARNING

To avoid injury, death, fire, explosion, leak, or property damage:

- The fluid waste from the drain connection **MUST NEVER BE** reintroduced into the incoming water stream. HF scientific recommends that operators review with local authorities concerning the proper disposal of waste diluted fluids.
- All plumbing connections **MUST BE** made through the provided stainless steel connections. Fittings should not be modified or substituted.
- The air line and the water line **MUST NOT BE** reversed in connecting the supplies. Connecting the water source to the air line will damage the electronics and void the warranty.
- All connections **MUST BE** properly installed and sealed to ensure water tightness and preserve the ratings of the instrument.
- The drain **MUST BE** open to the atmosphere for proper operation. Ensure the vent drain remains open and is not subject to fouling.

All wet and air connections are made with user supplied tubing using the compression fittings attached to the SSR-Ex. When using the compression fittings, follow these steps:

- Step 1: Unscrew the nut from the applicable connection point.
- Step 2: Remove the nut, front sleeve, and back sleeve from the SSR-Ex.
- Step 3: Place the nut, then the back sleeve, and then the front sleeve onto the applicable tubing.
- Step 4: Slide the tubing into the open connection point and tighten the nut to secure the tubing. Refer to Figure 9. Fitting Connections for assistance to assemble the tubing connection. Refer to Figure 10 - Utility Connections for assistance locating the proper fitting connection on the enclosure for the sample to be connected.

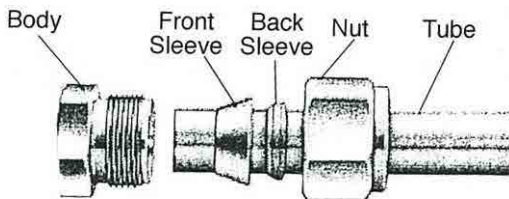

Figure 9 - Compression Fitting

NOTICE

When making the plumbing connections, be advised that:

- The maximum pressure for proper operation is 3 bar (45 PSI).
- The maximum sample water intake and drainage flow is 150 ml/minute.
- The maximum allowable fluid temperature is 55°C (131°F).
- The sample water supply does not need to be pressurized. The SSR-Ex incorporates a pressure regulator at the water supply inlet.
- In order to ensure that the sample measured is representative of the ballast water, keep sample pipe runs as short as possible.
- A water shut off valve should be located close to the instrument to allow for periodic maintenance.
- An air shut off valve should be located close to the instrument to allow for periodic maintenance.



EMERGENCY DRAIN (NO CONNECTION NEEDED)

SAMPLE WATER (6mm connection)

MAIN DRAIN (12 mm connection)
PURGE AIR (AIR ONLY 6mm connection)

NOTE: IMAGE DEPICTS BOTTOM OF THE ENCLOSURE.

DO NOT MIX UP THE AIR and WATER CONNECTIONS. INSTALLING THE WATER INTO THE AIR CONNECTION WILL VOID THE WARRANTY.

Figure 10 - Utility Connections

All wet and air connections are made with user supplied OD tubing using the compression fittings attached to the SSR-Ex. All air and water tubing connected to the instrument is to be supplied by others. When using the compression fittings, see Figure 9 - Compression Fitting and then follow these steps:

⚠ WARNING

Do not connect sample water line to the purge air connection.

Plumbing Connections

- Step 1: Connect the sample water line to the SSR-Ex using the 6 mm OD fitting on the bottom of the enclosure. Reference Figure 10 - Utility Connections.
- Step 2: Connect the main drain line to the SSR-Ex using the 12 mm OD fitting on the bottom of the enclosure.

Reference Figure 10 - Utility Connections. There is no tubing connection for the emergency drain.

Air Connection

- Step 1: Install the air/filter dryer assembly by mounting it in a convenient location near the SSR-Ex between the compressed air supply and the SSR-Ex.
- Step 2: Connect the compressed air supply to the air/filter dryer assembly intake.
- Step 3: Connect the air supply tubing from the air/filter dryer assembly output to the SSR-Ex using the 6 mm OD fitting on the bottom of the enclosure. Reference Figure 10 - Utility Connections.

4.3 Electrical Connections

⚠ WARNING



The power must be provided by a safe remote location. All power must be removed from a safe location while the electrical compartment access is open. Do not reconnect power until the electrical compartment access is closed and all captive Philips screws have been replaced and tightened appropriately.

All electrical connections are located in the upper electrical compartment. The electrical compartment access at the front can and should only be opened during installation. No power should be applied until the electrical compartment access is closed and sealed.

The SSR-Ex has two types of electrical connections. First, the mains power connection, which connects to the Air Sentinel II through the cable gland on the left side of the SSR-Ex. Second, the low voltage connections, which are made through the cable glands on the right side of the SSR-Ex.

⚠ WARNING

All low voltage connections should be completed before the main power is connected to system.

All electrical connections must pass through a compression gland. The glands can accept cabling from 11 to 21 mm in diameter. After installation, the glands must be tightened to ensure that the SSR-Ex maintains cabinet air pressure.



Figure 11 - Low Voltage Connections

4.3.1 Low Voltage Connections

All of the low voltage electrical communication connections to the instrument are made at the termination area located on the right side of the main PCB. To access the connections, lower the access flap by loosening the captive Phillips screws. The connections are labeled and are self-descriptive. Please follow all government recommendations and requirements for installation of electrical connections to and between the instrument and other peripheral devices. All terminals are designed to accept wires in the range of 14 - 28 AWG.

⚠ CAUTION

**Mains power connects only to the Air Sentinel II.
No mains power should be connected directly to the main PCB.**

4.3.1.1 Relays

Two relay alarm connections labeled COM1, NC1 & NO1 and COM2, NC2 & NO2 are provided. The relays are rated 240VAC 2A. Operation of this alarm is covered in section 4.2.1.5 Alarms Menu.

4.3.1.2 4 - 20 mA Analog Output

These connections are located on the mid right side of the Main PCB.

The 4 - 20 mA output is driven by a 24 VDC power source and can drive recorder loads up to 1000 ohms. Transformer isolation is provided on the SSR-Ex. Operation of this output is covered in section 4.2.1.3 - Analog Output Menu.

Polarities of the connections are labeled beside this termination on the PC board.

The recommended cable is 22 AWG shielded twisted pair. To prevent ground loops, connect the shield at its destination. The terminal block is removable to assist in making connections.

The 4 - 20mA is factory calibrated. An adjustment is available on the 4 - 20mA in section 4.2.1.3 Analog Output Menu. In addition to making adjustments, these menu output continuous 4 mA or 20 mA and can be used as a signal test. The configuration mode will timeout after 15 minutes.

4.3.1.3 Modbus

The RS-485 half-duplex (2-wire) digital interface operates with differential levels that are not susceptible to electrical interferences. Therefore, cable lengths up to 3000 ft can be implemented. The last device on every bus may require a 120-ohm termination resistor to eliminate the possibilities of signal reflection on the line. Do not run RS-485 cables in the same conduit as power.

Ensure each instrument is not powered when connecting the RS-485 line. To prevent damage to the instrument, ensure that power is disconnected prior to making connections. The Modbus connection is located on the lower right portion the main PCB as seen on Figure 11.

4.3.1.4 RMT

By design the SSR-Ex will only be actuated for measurement by a remote command. The system can be set up to either be actuated through MODBUS or by means of a remote actuation provided by the end user.

These connections are located in the lower right corner of the main PCB. See Figure 4 - Low Voltage Connections.

The instrument operates on user control software, where an external control initiates each cycle. The SSR-Ex will indicate the current status of connections using a relay contact that is closed when busy and open when in standby mode.

4.3.1.5 Securing the Glands - Low Voltage

Low voltage connections to the instrument are made through electrical glands located on the right side of the enclosure. Once the appropriate low voltage wiring is inserted through the electrical gland and wiring is secured at the terminals on the main circuit board glands on the right side of the enclosure must be tightened to ensure wiring is safely installed.

4.3.2 Mains Power Connections

Once all low voltage connections are made, the mains power should be connected through the Air Sentinel II. Reference Figure 3 – Close-up of Electrical Compartment.

4.3.2.1 Securing the Glands - Mains Power

Mains power connection to the instrument is made through an electrical gland located on the left side of the enclosure. Once the mains power wiring is inserted through the electrical gland and wiring is secured at the mains power terminals of the Air Sentinel II electrical gland on the left side of the enclosure must be tightened to ensure mains power wiring is safely installed.

4.4 Hardware Control

The connections are labeled RMT Stby. The input has + and - polarity connections and requires an external 24VDC control signal.

The output is simply a relay contact and is not polarized. After the SSR-Ex completes a cycle of measurement, the unit will return to standby awaiting another pulsed signal to measure. Alternately, 24VDC can be continuously applied and the SSR-Ex will take readings until the 24VDC is removed. When power is removed it will complete the current cycle. The measured value will remain displayed until the next measurement.

4.5 Modbus Control

In addition to the above mentioned Remote Standby Connections, control can also be achieved using Modbus control. Two special Modbus addresses are provided. The reading cycle is initiated using the Coil Address 00005 with the default at False (0). Setting this Address to True (1) initiates the reading cycle.

At any time the standby status can be checked at Modbus Coil Address 00005 or Modbus Input Address 10005. False (0) indicates standby and True (1) indicates the measurement cycle is taking place. Control is only available from the Coil Address 00005 for more setting information refer to Section 4.2.1.4. - Modbus Menu.

The default communication parameters are 8 bits, no parity and 1 stop bit. Please note that all Modbus communication is via RS-485. The instruments can support a two wire multidrop network of 255 units. If the connection is to the master on USB, an RS-485 to USB converter is required.

4.5.1 Coils

These single-bit values are readable and changeable from the master. The data will be returned with the lowest addressed coil in the least significant bit (LSB) of the data. Unused bits in the data will be set to 0. True is a 1 and False is 0.

4.5.1.1 Valid Command(s)

Code	Name	Broadcast
0x01	Read Coil Status	No
0x05	Force Single Coil	Yes

4.5.1.2 Format

16-bit word format

MSB																				LSB
Bit 15	Bit 14	Bit 13	Bit 12	Bit 11	Bit 10	Bit 9	Bit 8	Bit 7	Bit 6	Bit 5	Bit 4	Bit 3	Bit 2	Bit 1	Bit 0					

4.5.1.3 Valid Addresses

00001 – 00XXX

4.5.1.4 Definitions

Address	Function	Default
00001	NOT USED	False
00002	NOT USED	False
00003	NOT USED	False
00004	Service mode (Go into service mode if true)	False
00005	FDI (flag data in) False means waiting for a command. Standby mode. True means start a cycle.	False
00006	Zero Flag – Zero the reading if True	False
00007	Prime mode – Start a prime if True	False

4.5.2 Input Status

These single-bit values are readable from the master. The data will be returned with the lowest addressed input status in the least significant bit (LSB) of the data. Unused bits in the data will be set to 0.

4.5.2.1 Valid Command(s)

Code	Name	Broadcast
0x02	Read Input Status	No

4.5.2.2 Format

16-bit word format

MSB																				LSB
Bit 15	Bit 14	Bit 13	Bit 12	Bit 11	Bit 10	Bit 9	Bit 8	Bit 7	Bit 6	Bit 5	Bit 4	Bit 3	Bit 2	Bit 1	Bit 0					

4.5.2.3 Valid Addresses

10001 – 10XXX

4.5.2.4 Definitions

Address	Function	Default
10001	Instrument error	False
10002	Instrument error with alarm	False
10003	Alarm 1 active	False
10004	Alarm 2 active	False
10005	FDO (flag for data out) False means waiting for a command to start. True means going through a cycle (busy).	False

4.5.3 Holding Registers

These 16-bit values are readable and changeable from the master. The data is stored and transmitted with the most significant bit (MSB) first and then the least significant bit (LSB).

4.5.3.1 Valid Command(s)

Code	Name	Broadcast
0x03	Read Holding Registers	No
0x06	Preset Single Register	Yes
0x16	Preset Multiple Registers	Yes

4.5.3.2 Format

Float – stored in two consecutive addresses, with the first address containing the least significant word (lower part of mantissa) and the second address containing the most significant word (sign, exponent, and upper part of mantissa).

4.5.3.3 Valid Addresses

40001 – 40XXX

4.5.3.4 Definitions

Address	Type	Register	Min	Default	Max	Function
40001	Int	NOT USED	0	0	0	
40002	Int	Units (scaling)	0	0	1	0 – PPM 1 – MG/L
40003	Int	Readings Per Average	1	2	5	Number of readings used for averaging
40004	Int	LCD backlight	10	80	100	Percent. Higher is brighter
40005, 40006	Float	4-20 mA minimum value	0.0	0.00	15.0	Scaling value
40007, 40008	Float	4-20 mA maximum value	0.0	15.00	15.0	Scaling value
40009	Int	4-20 mA error alarm output	0	2	3	0 – Off 1 – 0 mA 2 – 2 mA 3 – 4 mA

Address	Type	Register	Min	Default	Max	Function
40010	Int	RS-485 baud	0	3	4	0 – 1,200 1 – 2,400 2 – 4,800 3 – 9,600 4 – 19,200
40011	Int	NOT USED	0	0	0	
40012	Int	RS-485 parity	0	0	2	0 – None 1 – Even 2 – Odd
40013	Int	RS-485 stop bits	0	1	1	0 – One 1 – Two
40014	Int	Instrument address	1	1	255	Slave address
40015	Int	Modbus serial mode	0	0	1	0 – RTU 1 – ASCII
40016	Int	Alarm 1 type	0	0	3	0 – Off 1 – Low alarm 2 – High alarm 3 – Error alarm
40017, 40018	Float	Alarm 1 set point	0.0	0.0	15.0	
40019	Int	Alarm 2 type	0	0	3	0 – Off 1 – Low alarm 2 – High alarm 3 – Error alarm
40020, 40021	Float	Alarm 2 set point	0.0	0.0	15.0	
40022	Int	Not used	0	0	0	Not used
40023	Int	Contact time	0	0	600	Seconds before starting measurements (steps of 15sec.)
40024	Int	Measurement period	45	45	600	Seconds for measurements to complete
40025	Int	Standby purge	0	24	100	Hours between pulsing of reagent pumps (0 = OFF, no pulsing)

4.5.4 Input Registers

These 16-bit values are readable by the master. The data is stored with the most significant bit (MSB) first and then the least significant bit (LSB).

4.5.4.1 Valid Command(s)

Code	Name	Broadcast
0x04	Read Input Registers	No

4.5.4.2 Format

Float – stored in two consecutive addresses, with the first address containing the least significant word (lower part of mantissa) and the second address containing the most significant word (sign, exponent, and upper part of mantissa).

4.5.4.3 Valid Addresses

30001 – 30XXX

4.5.4.4 Definitions

Address	Type	Register	Function
30001, 30002	Float	Sensor reading	The meter reading
30003, 30004	Float	ABS	The absorbance
30005	Int	Main version	Main board software version
30006	Int	Display version	Display board software version
30007	Int	NOT USED	
30008	Int	Model number	28037
30009	Int	Model suffix number	Options – model dependent 0
30010	Int	Reading status	0 – unknown 1 – normal 2 – over range 3 – under range 4 – need standard 5 – need sample 6 – reading problem (Reading error) Above will display last reading twice then 0.00 is displayed.
30011	Int	NOT USED	
30012	Int	Instrument error summary (bit-mapped)	0x00000 – normal 0x00001 – Error 0x00002 – Alarm 1 is active 0x00004 – Alarm 2 is active 0x00008 – Calibration error 0x00010 – Optical error 0x00020 – 12-volt power supply (Fatal error) 0x00040 – Purge solenoid 0x00080 – Reagent solenoid (Halting error) 0x00100 – STM32 internal A/D converter (Fatal error) 0x00200 – STM32 flash data read (Fatal error) 0x00400 – STM32 flash data write (Fatal error) 0x00800 – LTC2400 A/D problem (Fatal error)

4.5.5 Exception Responses Implemented

Code	Name	Meaning
00	--	No error
01	ILLEGAL FUNCTION	The function code is not allowed in the device.
02	ILLEGAL DATA ADDRESS	The data address is not allowed in the device
03	ILLEGAL DATA VALUE	A value contained in the query field is wrong for the device

4.6 Securing the Electrical Enclosure

Once all electrical connections are made, the electrical enclosure must be secured by closing the compartment and tightening the captive Phillips screws.

5.0 Configuration - General Process

5.1 Instrument Commissioning and Start-up

After all water, air, and electrical connections have been made, the SSR-Ex can be powered on by turning on the power to the Air Sentinel II. Once power is supplied to the Air Sentinel II, it will run through an automatic three-minute purge cycle and then supply power to the SSR-Ex. If at any time there is a loss of pressurization in the electrical enclosure, the Air Sentinel II will remove power to the SSR-Ex.

The condition of the Air Sentinel II can be determined based on the color of the LED lamps on its body as explained by this chart:

Lamp Color Matrix	Meaning	Power to Attached Device	Alarm Relay Response
Both Lamps GREEN	Safe Operation	ON	Normally Open Contacts OPEN
TIMER Lamp RED	Instrument is Purging	OFF	Normally Open Contacts CLOSE
PRESSURE Lamp RED	Unsafe Operation	OFF	Normally Open Contacts CLOSE
NO Lamps	No power out applied	No power applied; everything off	

The SSR-Ex is ready for operation when the Air Sentinel II displays two green LED lamps.

5.2 Configuring the SSR-Ex

The SSR-Ex is configured using the buttons located on the outside of the electrical enclosure. The Mainscreen is shown below in Figure 12 - Main Screen.

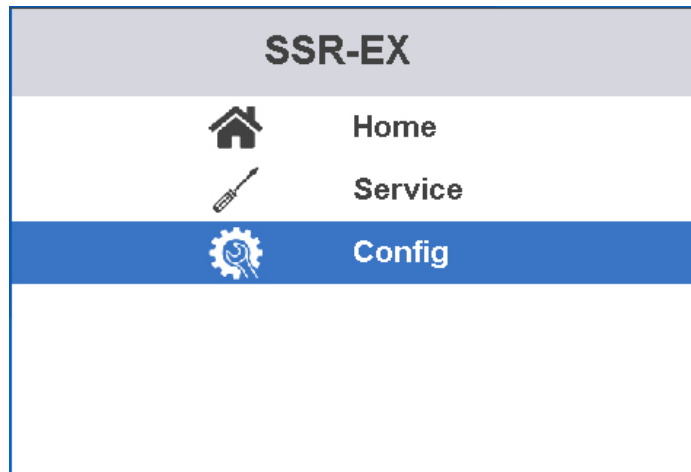

Figure 12 - Main Screen

Using the UP and DOWN buttons, navigate to the desired function shown on the screen. Once you have highlighted the desired function press

SELECT to display the next menu.

The Service and Config menus permit access to the processes listed in the charts below. Use the EXIT button to return to the previous screen.

Service Menu Options

Title	Function/Description
PRIME	Prime DPD and Buffer Reagents.
CALIBRATE	Initiate Calibration Procedure. Follow prompts to complete.
WATER PRIME	Actuate the sample pump to flush the water lines.

Config Menu Options

Title	Function/Description
ANALOG OUTPUT	Configure 4 - 20 mA Output
MODBUS	Configure MODBUS
ALARMS	Configure Alarms
UNITS	Select PPM or mg/l
AVERAGE	Select Signal Averaging 1 - 5 cycles
BACKLIGHT	Adjust Display Backlighting
CYCLE TIME	Reading Update Rate
CONTACT PERIOD	Permits Chlorine Contact time before measuring
STANDBY PULSE	Pulses reagent to reduce clogging while in standby
RESTORE DEFAULTS	Restores factory default settings
RESTORE FACTORY CAL.	Restore factory calibrations
ABOUT DEVICE	Displays the DISPLAY and MAIN software version numbers

5.2.1 Menu Selection Options

5.2.1.1 Main Menu

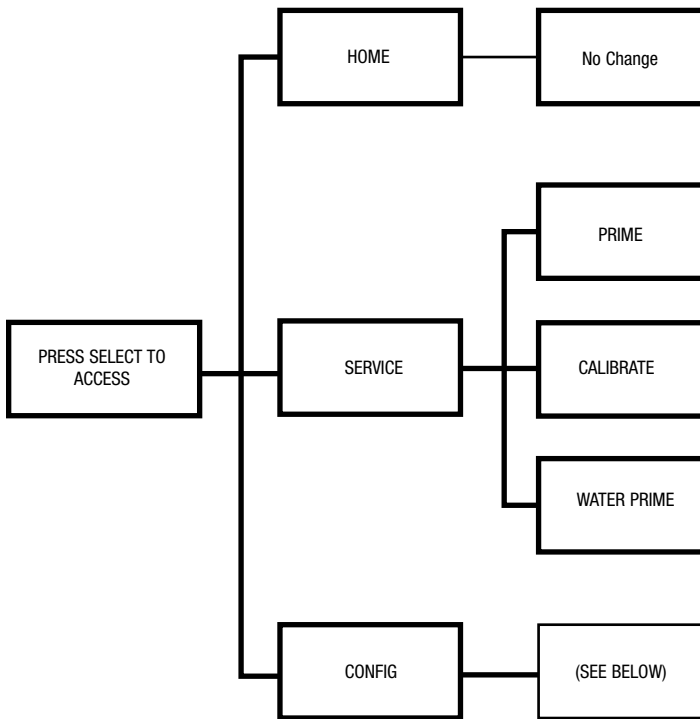

SERVICE MENU By design the SSR-Ex will only be actuated for measurement by a remote command. The system can be set up to either be actuated through MODBUS or by means of a remote actuation provided by the end user.

PRIME function pulses the reagent pumps to ensure the reagent lines are filled with reagent.

CALIBRATE function allows you to calibrate the SSR-Ex in the field. Please refer to Section 5.1 - Calibration for the calibration procedure.

WATER PRIME function allows the sample pump to be actuated to flush the water line to the SSR-Ex in order to expedite delivery of representative sample to the SSR-Ex.

Every time SERVICE mode is exited, all faults are cleared. If the original fault or a new fault occurs, it will be posted to the display. Faults will not stay cleared until the fault condition is no longer detected.

5.2.1.2 Config Menu

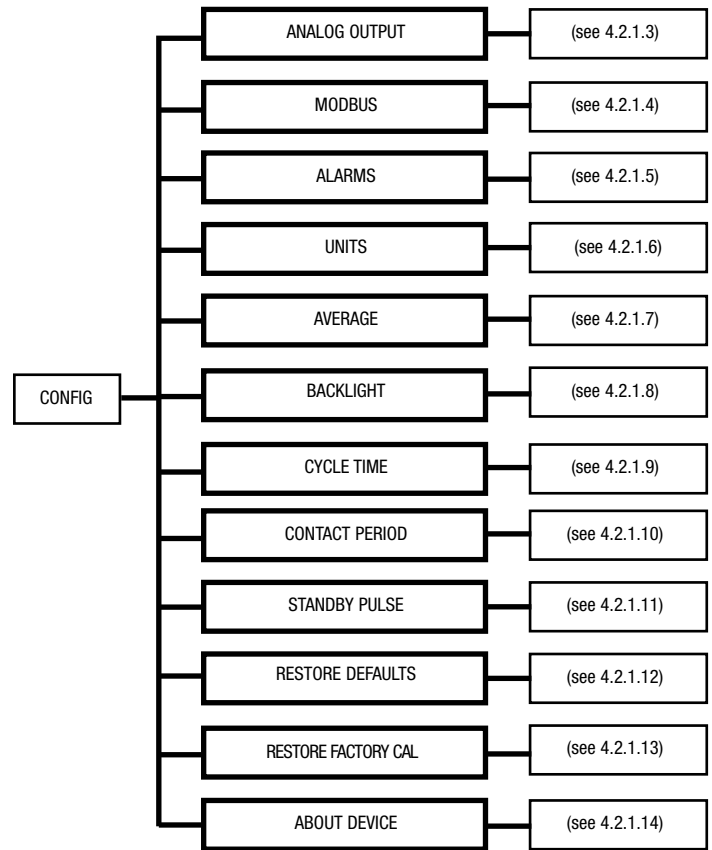

(Select using UP & DOWN buttons)

Once changes have been made to the settings, the SSR-Ex will display the prompt "Are you sure?" To save the changed settings, press the SELECT button.

5.2.1.3 Analog Output Menu

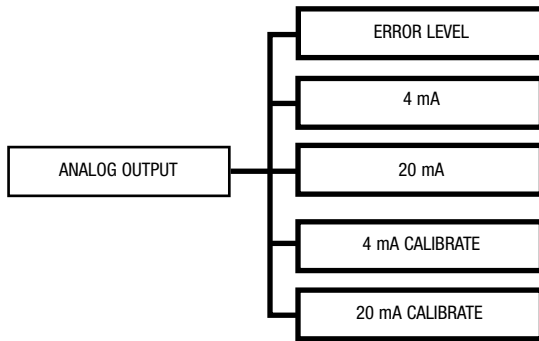

Select using UP & DOWN buttons)

SSR-Ex allows the user to determine how an error message will affect the analog outputs. Settings include driving the analog output either to 0 mA, 2 mA, or 4 mA or the setting can be OFF to not affect the output.

Default value is OFF.

SSR-Ex allows the analog output to be scaled to the desired range using the 4 mA and 20 mA adjustments. Select either 4 mA or 20 mA and using the UP & DOWN buttons adjust to the desired value.

Default values are 4 mA = 0 ppm and 20 mA = 15 ppm

The 4 and 20 mA outputs can be offset to account for signal loss between the SSR-Ex and the SCADA system using the 4 mA and 20 mA CALIBRATE options.

5.2.1.4 Modbus Menu

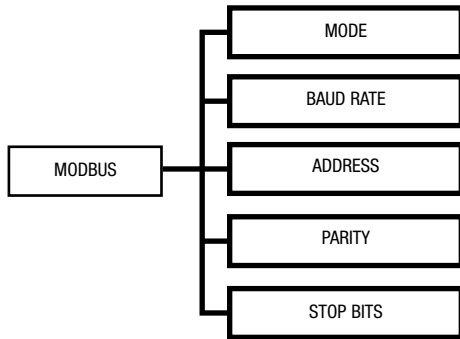

The factory default setting is 9600, 8 bit, no parity, 1 stop bit, RTU. All parameters are adjustable. Make sure the parameters on the Host and the SSR-Ex are configured identically.

(Select using UP & DOWN buttons)

These settings allow the user to configure the SSR-Ex MODBUS. Settings include the MODE, BAUD RATE, ADDRESS, PARITY and BITS.

5.2.1.5 Alarms Menu

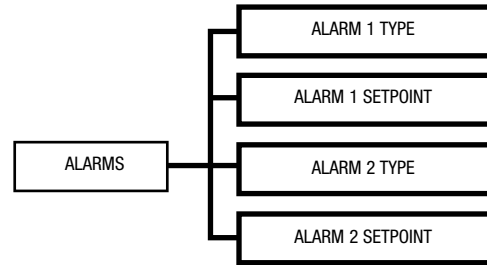

(Select using UP & DOWN buttons)

SSR-Ex allows the alarms to be configured to be either HI, LO, OFF or ERROR and the set points can be configured to actuate the relays at the desired values.

5.2.1.6 Units Menu

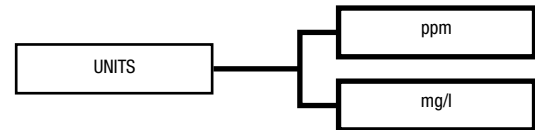

(Select using UP & DOWN buttons)

SSR-Ex will display units in either ppm or mg/l. Default value is ppm.

5.2.1.7 Average Menu

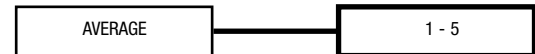

(Select using UP & DOWN buttons)

SSR-Ex averages the selected number of readings and displays the average on the display MODBUS and on the analog output.

Default value is 2.

5.2.1.8 Backlight Menu

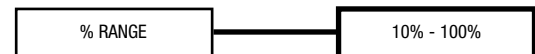

(Select using UP & DOWN buttons) Change is in increments of 10.

Default value is 80%.

5.2.1.9 Cycle Time Menu



(Select using UP & DOWN buttons) Values are in seconds.
Default value is 45 seconds.

The SSR-Ex will perform a test based on the cycle time interval selected and actuation by means of MODBUS or RST.

5.2.1.10 Contact Period Men

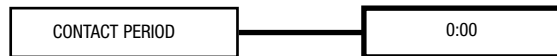

(Select using UP & DOWN buttons)

The range 0:00 to 10:00 in minutes and seconds. The default is 00:00

This setting enables the user to allow contact time with the ballast water and selected oxidant.

5.2.1.11 Standby Pulse Menu



(Select using UP & DOWN buttons)

This setting will energize the reagent pumps to ensure the lines remain free of clogs. Range of settings is 1 - 100 hours. Setting below 1 turns the function OFF.

Default setting is ON and default time is 24 Hr.

5.2.1.12 Restore Defaults Menu



This option will restore the factory default settings. Screen displays "RESET DEFAULTS?" Pressing the SELECT button will restore factory default settings. Before performing a Restore Defaults it is advised to make a listing of any user changed menu options prior to the reset.

5.2.1.13 Restore Factory Cal Menu

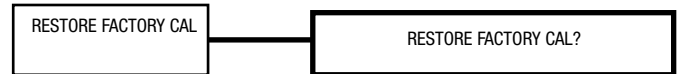

This option will restore the factory default calibration. Screen displays "RESTORE FACTORY CAL?" Pressing the SELECT button will restore the factory calibration. This will restore the factory reading, 4 and 20mA calibrations.

5.2.1.14 About Devise Menu

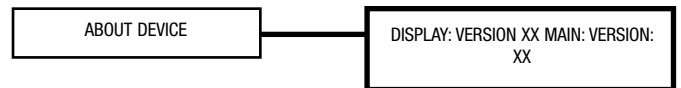

(Select using UP & DOWN buttons)

This option will display the DISPLAY and MAIN software version numbers.

5.3 System Start-up

Once the SSR-Ex is powered on, air has been purged, and all configurations have been completed, it is ready for use.

5.3.1 Flush Water Sample Line

Before sampling any sample water, the water line from the source water to the enclosure must be flushed to ensure that the sample line has a representative sample and is not impacted by any debris or other foulants. Flush the sample line by using the WATER PRIME feature found under the SERVICE menu. When this feature is selected, the connected water sample line will automatically flush water to drain.

Reference section 4.2.1.1 main menu.

5.3.2 Prepare Reagents

Prepare and install the reagents according to the instructions provided on the reagent bottles. In the SERVICE menu, select PRIME to prime the reagents. You can access the bottom of the enclosure to service these items, if needed.

5.3.3 Remote Start

Once the line is flushed and the reagents primed, initiate a cycle remotely through RMT or MODBUS.

NOTICE

The SSR-Ex will only operate using a remote start signal.

5.4 Typical Cycle

During normal operation, the SSR-Ex will run through a timed cycle. A simplified cycle will consist of the following sequences:

Flushing – sample flow
Purging – PURGE valve opens
Zeroing – no flow with cuvette full
Adding Reagents – one pulse of the reagent pumps
Sample Reaction – reaction of reagents with oxidant sample
Reading resulting sample – no flow with cuvette full
Purging – PURGE valve opens to remove the reacted sample and water

The cycle above is simplified and does not describe all the actions and testing that occurs. The CPU continuously diagnoses the entire system for correct operation and sample water flow. If an error occurs, a message is posted on the LCD screen and is indicated on a Modbus address. Alarm contact closure can be user configured to provide an alarm in the event of an error message.

5.5 Observe Operation

Observe the process in the optical assembly, you should see a vortex of water form as the SSR-Ex flushes water through the cuvette, then the unit will stop water flow and “zero” on the source water, flush again and then actuate the reagent pumps and take

6.0 Maintenance

WARNING

Under normal operating conditions, it is recommended that the main enclosure door is closed. If the electrical or power devices in the purged (upper) section of the enclosure needs to be accessed for service, ensure all power has been removed from a safe location before accessing the electrical or powered devices in the electrical enclosure.

The SSR-Ex instrument is sectioned such that all the electrical or powered devices are in the upper, purged section of the enclosure, while the lower (wetted parts) section contains no power at all and can be operated and maintained in a safe condition even with the main enclosure door open. In the interest of safety, if the electrical or power devices in the purged (upper) section of the enclosure needs to be accessed for service, ensure all power has been removed from a safe location prior to accessing the electrical or powered devices in the electrical enclosure. All components in the lower (wetted parts) section of the enclosure can be accessed for service or routine

maintenance, while the SSR-Ex instrument is powered, air supplied, and while the main enclosure door is open. Under normal operating conditions, it is recommended that the main enclosure door is closed. In cases where the SSR-Ex instrument is in an environment considered to be Zone 0 for a period of time, power and air to the instrument must be removed.

General Condition Check - Once a month check the general condition of the instrument in operation by opening the enclosure door and visually inspecting the instruments wet chemistry section components to confirm proper operation and to also check for any leaking components or other concerns. The wet section components can be accessed for maintenance, reagent replacement and visual inspection during voyages.

NOTICE

Specific condition of use: Parts of the enclosure are non-conducting and exceed the maximum permissible resistance according to the IEC 60079-0. Therefore, to avoid electrostatic charge build-up, it must not be rubbed or cleaned with solvents or a dry cloth when installed/used within a potentially explosive atmosphere.

6.1 Calibration

Calibration kit (Cat. No. 28144S) includes:

125 ml of zero solution (solution #1)

125 ml of calibration solution (solution #2) 1 each replacement cuvette

The SSR-Ex instrument was tested and calibrated prior to leaving the factory. The instrument operates from a pre-determined calibration curve for high accuracy of residual oxidant concentration. It is not necessary to recalibrate to maintain stated accuracy specifications. If re-calibration is required by a regulatory authority, calibration can easily be accomplished in the field using the procedure below.

- Step 1: Ensure the supply water is shut off. From the control buttons, enter the calibration screen. Follow the on-screen instructions.
- Step 2: Disconnect the black tubing from the pressure regulator to the pump. Some water may drain from the regulator, this is normal and it may be appropriate to use a container to catch the small volume of water.
- Step 3: Insert the black tube into solution #1. This is used to set a zero reference. Follow the instructions on the display.
- Step 4: When the SSR-Ex has completed the zero procedure you will be instructed to move the tube to solution #2. Follow the instructions on the display.
- Step 5: The SSR-Ex will take a reading of the solution. If this reads from 9-11 mg/l (PPM), the instrument is operating within the stated specifications and no further action is required. If the reading is outside of this range the SSR-Ex will allow you to make an adjustment to bring it into range. Follow the instructions displayed on the SSR-Ex.
- Step 6: Restore the black tube to the pressure regulator and turn the water supply back on. Check for leaks before closing the enclosure door.



Figure 13 - Pressure regulator and T-strainer

6.2 Cuvette Replacement

HF scientific recommends that the cuvette be replaced annually or if it appears badly soiled or discolored at any time. It is suggested to place a covering over a floor grate if the instrument is installed over a grate.

To replace the cuvette:

- Step 1: Press SERVICE to stop the flow of sample water and drain the cuvette.
- Step 2: Ensure the source water is turned off.
- Step 3: Turn counterclockwise, but do not completely remove, the knurled fitting on top of the optics system to loosen the cuvette. Occasionally it is necessary to very gently rotate the cuvette on the O-rings to facilitate removal. Once the cuvette rotates easily on the O-rings carefully remove the cuvette. There is a spring installed in the optical block to facilitate removal of the cuvette.
- Step 5: Reverse the procedure to install a new or cleaned cuvette.
- Step 6: Retain the removed cuvette for future use if it can be cleaned.

Refer to Figure 5 - Wet Chemistry Area of Enclosure

Install the new cuvette by pushing it firmly but gently to seat it on the O-rings, carefully turn the knurled top clockwise until the cuvette is held level and securely against both the top and bottom O-rings, do not overtighten. Return to normal operation.

6.3 T-Strainer Cleaning

The T-strainer is integral to the instrument and must be checked when changing the reagent. When necessary the T-strainer screen and bowl must be cleaned. The T-strainer is clamped to the door and does not require removal to be cleaned. You may want to place a container under the instrument to catch the water and debris during cleaning.

- Step 1: Press SERVICE to stop the flow of sample water and drain the cuvette.
- Step 2: Ensure the source water is turned off.
- Step 3: Disconnect the top (bowl) of the T-strainer by turning counterclockwise.
- Step 4: Remove and clean the screen and the bowl and then reassemble.
- Step 5: Be sure to tighten the bowl of the strainer.
- Step 6: Turn source water back on.
- Step 7: Return to normal operation.
- Step 8: Check for any leaks.

The T-strainer screen (Cat. No. 28625) may require replacement after a period of time or as needed.

6.4 Adjusting the Pressure Regulator

The pressure regulator is factory set and it should not be necessary to adjust it in the field.

6.5 Installing New Reagent in the SSR-Ex

Use caution when changing the reagents, as they are corrosive. These reagents may stain clothing. After changing the reagents, operators should wash their hands.

- Step 1: Press SERVICE to stop the flow of sample water and drain the cuvette.
- Step 2: Ensure the source water is turned off.
- Step 3: Remove both reagent bottles by unscrewing cap assembly.
- Step 4: The buffer is installed on the right and the indicator is installed on the left.
- Step 5: Once bottles are secure in the bracket, wrap the Velcro around both bottles to ensure they do not move.
- Step 6: Screw cap on the bottle and ensure a tight fit. Ensure tubing is fully submerged at the bottom of the bottle.
- Step 7: Follow the PRIME procedure under the SERVICE menu. This will draw enough of each reagent to completely prime the tubes and replace any old solution. The system will automatically return to normal operation after it completes the prime.

6.6 Replacing the Peristaltic Sample Pump Head

The pump head assembly can be replaced. Recommended replacement for the pump head assembly is annually. It is replaced as a complete assembly, not just the pump tube. The pump is located in the upper right of the wet enclosure.

- Step 1: Press SERVICE to stop the flow of sample water and drain the cuvette.
- Step 2: Ensure the source water is turned off.
- Step 3: Squeeze the right side of the pump housing, this will release the pump head from the bracket and a new pump head can be installed.
- Step 4: Disconnect the inlet and outlet sample tubes from the pump once it has been removed from the pump base taking care to note which tube connects to which side of the pump head.
- Step 5: Connect the inlet and outlet sample tubing to the new pump.
- Step 6: Carefully replace the pump head in the enclosure.

6.7 Instrument Storage

If the SSR-Ex is relocated or will be inactive for long periods of time (several months).

- Step 1: Press SERVICE to stop the flow of sample water and drain the cuvette.
- Step 2: Ensure the source water is turned off.
- Step 3: Remove the reagents.
- Step 4: Flush the reagent sample lines with distilled water. Flush the reagent system.
- Step 5: Remove power by disconnecting the mains power.
- Step 6: It is usually a good idea to disconnect or shut off the source water for the duration of storage.

To order any accessory or replacement part, please contact the HF scientific Customer Service Department. If for any reason technical assistance is needed regarding this instrument, please do not hesitate to contact the HF scientific Technical Services Department.

7.0 Diagnostic/Troubleshooting Chart

Symptom	Cause	Cure
Display shows MA	4 - 20 mA loop open	Check wiring
Display shows FAIL	Major system fault	Contact HF scientific Technical Support
Readings are erratic	(1) Bubbles in solution (2) Debris in water sample	(1) Check for air leaks (2) Clean T-strainer at inlet
Readings are lower than expected	(1) Leaky measurement cuvette (2) Measurement cuvette dirty (3) Reagents bad or expired (4) Buffer reagent not	(1) Check seating of cuvette on the O-rings (2) Replace or clean cuvette (3) Replace reagents (4) Attempt a prime procedure, check the status of reagent pump(s)
Display flashes	Sample Over-Range	Check sample. Sample may be too high to read.
Display shows none while attempting to calibrate	No current reading displayed	Wait for SSR-Ex to post a reading
No display on SSR-Ex	Air Sentinel II issue with air supply	Troubleshoot air supply system and Air Sentinel II

8.0 Error/Alarm Messages and Suggested Actions

ERROR DISPLAYED	Definition	Suggested Action
Solenoid 1	Reagent solenoid 1 problem	Test solenoid, try factory reset
Solenoid 2	Reagent solenoid 2 problem	Test solenoid, try factory reset
Drain Valve Error	Problem with the drain valve	(1) Flush the SSR-Ex (2) Clean the drain solenoid (3) Clean the optical assembly drain orifice
4 - 20 mA Output Error	Analog output problem	Check for open loop
12 V Monitor Error	Power supply Issue	On board power supply problem, try factory reset
Optical Sensor Error	Measurement error	Wait for SSR-Ex to post a reading, try factory reset
EEPROM Error	Non-volatile error	Try factory reset
Main Board Lost	Internal communication loss	Check cable connections, try factory reset
Low Setpoint Alarm	Reading below set point	Check source water oxidant level
High Setpoint Alarm	Reading above set point	Check source water oxidant level

9.0 Technical and Customer Assistance

If for any reason assistance is needed regarding this instrument please do not hesitate to contact either the HF scientific Technical Service Department or the HF scientific Customer Service Department:

10.0 Spare Parts Listing

Part/Kit Name	Description	Frequency of part or kit change
Calibration Kit - 28144S	Description - Includes 125 ml solution #1, 125 ml solution #2, and a spare cuvette	Frequency – As required by regulatory authority
Air/Filter Dryer Assembly - 28139	Description - Includes air prep assembly and appropriate fittings	Annual or when red indicator is shown. See kit below.
Air Filter/Dryer Element Replacement Kit - 28140S	Description - Qty. 1 AMG-EL150, Qty. 1 AF20P-060S, and Qty. 1 AMH-EL150	As needed
TOTAL Chlorine SSR-Ex DRY REAGENT KIT (30 Day Supply) - 110186	Description - Includes DPD tube, Indicator, Buffer in reagent bottles, MSDS documents	As needed
TOTAL Chlorine SSR-Ex Liquid REAGENT KIT (30 Day Supply) - 110187	Description - Includes DPD tube, Indicator, Buffer in reagent bottles, MSDS documents	As needed
T-Strainer/ Pressure Regulator Assy - 28143S	Description - Includes both the T-strainer and pressure regulator assembly.	As needed
Replacement T-Strainer Screen - 28145S	Description - Includes Qty. of 1, replacement T-strainer screen	As needed
Replacement Peristaltic Pump Head - 28141S	Description - Includes replacement pump head	As needed
Reagent Tubing Kit - 28142S	Description - Includes Injectors, O-rings, Idex nuts, Ferrules, Coupling nuts and C-Flex tubing.	As needed
Pressure Regulator (Inlet Water) - 24320S	Description - Includes Qty. of 1, Watts® Pressure Regulator	As needed

To order any accessory or replacement part, please contact the HF scientific Customer Service Department. If for any reason technical assistance is needed regarding this instrument, please do not hesitate to contact the HF scientific Technical Services Department. Each spare part will include appropriate instructions of proper use.

11.0 Limited Warranty

Watts Regulator Co. (the "Company") warrants each ballast water market instrument product to be free from defects in material and workmanship under normal usage for a period of two (2) years from first use or three (3) years from date of the Company's invoice from the original sale of the product, whichever occurs first. In the event of such defects within the warranty period, the Company will, at its option, replace or recondition the product without charge. Parts which by their nature are normally required to be replaced periodically, consistent with normal maintenance, specifically reagents, desiccant, sensors, electrodes and fuses, are excluded. Also excluded are accessories and supply-type items.

Proof of purchase from the Company (Company invoice or paid order confirmation) and/or first use (commissioning) must be provided when making a product warranty claim.

THE WARRANTY SET FORTH HEREIN IS GIVEN EXPRESSLY AND IS THE ONLY WARRANTY GIVEN BY THE COMPANY WITH RESPECT TO THE PRODUCT. THE COMPANY MAKES NO OTHER WARRANTIES, EXPRESSED OR IMPLIED. THE COMPANY HEREBY SPECIFICALLY DISCLAIMS ALL OTHER WARRANTIES, EXPRESSED OR IMPLIED, INCLUDING BUT NOT LIMITED TO, THE IMPLIED WARRANTIES OF MERCHANTABILITY AND FITNESS FOR A PARTICULAR PURPOSE.

The remedy described in the first paragraph of this warranty shall constitute the sole and exclusive remedy for breach of warranty, and the Company shall not be responsible for any incidental, special or consequential damages, including without limitation, lost profits or the cost of repairing or replacing other property which is damaged if this product does not work properly, other costs resulting from labor charges, delays, vandalism, negligence, fouling caused by foreign material, damage from adverse water conditions, chemical, or any other circumstances over which the Company has no control. In addition, the Company shall not be responsible for any costs incidental to the Company's warranty response efforts, including, without limitation, costs associated with the removal and replacement of systems, structures or other parts of facilities, de-installation, decontamination and re-installation of products, or transportation of products to and from the Company. This warranty shall be invalidated by any abuse, misuse, misapplication, improper installation or improper maintenance, alteration of the product, or use of any parts or accessories (including but not limited to reagents) not provided by the company.

Some states do not allow limitations on how long an implied warranty lasts, and some states do not allow the exclusion or limitation of incidental or consequential damages. Therefore the above limitations may not apply to you. This Limited Warranty gives you specific legal rights, and you may have other rights that vary from State to State. You should consult applicable state laws to determine your rights. **SO FAR AS IS CONSISTENT WITH APPLICABLE STATE LAW, ANY IMPLIED WARRANTIES THAT MAY NOT BE DISCLAIMED, INCLUDING THE IMPLIED WARRANTIES OF MERCHANTABILITY AND FITNESS FOR A PARTICULAR PURPOSE, ARE LIMITED IN DURATION TO ONE YEAR FROM THE DATE OF ORIGINAL SHIPMENT.**



A WATTS Brand

USA: T: (239) 337-2116 • Toll-Free (888) 203-7248 • F: (239) 454-0694 • HFscientific.com

Latin America: T: (52) 55-4122-0138 • HFscientific.com