

## Engineering Specification

Job Name \_\_\_\_\_

Contractor \_\_\_\_\_

Job Location \_\_\_\_\_

Approval \_\_\_\_\_

Engineer \_\_\_\_\_

Contractor's P.O. No. \_\_\_\_\_

Approval \_\_\_\_\_

Representative \_\_\_\_\_

# Series 957RPDA

## Reduced Pressure Detector Assembly

2½" – 10"

### ⚠ WARNING

It is illegal to use this product in any plumbing system providing water for human consumption, such as drinking or dishwashing, in the United States. Before installing standard material product, consult your local water authority, building and plumbing codes.

Series 957RPDA Reduced Pressure Detector assembly provides protection to the potable water system from contamination in accordance with national plumbing codes. The assemblies are normally used in health hazard applications to protect against back-siphonage and backpressure, as well as to monitor unauthorized use of water from the fire protection system.

The series includes a flood sensor to detect excessive water discharges from the relief valve. The sensor is installed on the assembly exterior and does not alter assembly functions or certifications. The sensor relays a signal that triggers notification to facility personnel for corrective action, thus limiting flooding and costly damage.

### NOTICE

An add-on connection kit is required to activate the flood sensor. Without the connection kit, the sensor is a passive component that has no communication with any other device. (For more information download RP/IS-957/957DCDA.)

### Features

- Extremely compact design
- 70% lighter than traditional designs
- 304 (Schedule 40) stainless steel housing and sleeve
- Groove fittings allow integral pipeline adjustment
- Patented torsion spring check provides lowest pressure loss
- Unmatched ease of serviceability
- Replaceable check disc rubber
- Available with grooved butterfly valve shutoffs
- Bottom mounted cast stainless steel relief valve
- Metered bypass to detect leakage or theft of water from the fire sprinkler system
- Sensor on relief valve for flood detection
- Flood alert feature activated with add-on sensor connection kit, compatible with BMS and cellular network communication

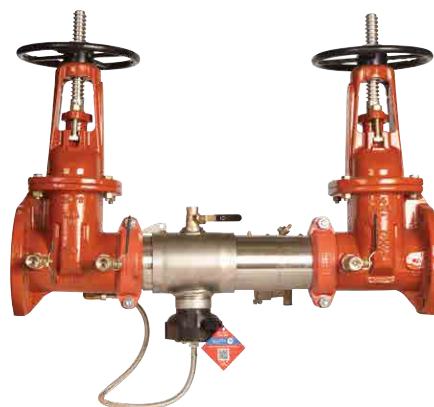

957RPDA-OSY with Flood Sensor

### NOTICE

Use of the flood sensor does not replace the need to comply with all required instructions, codes, and regulations related to installation, operation, and maintenance of this product, including the need to provide proper drainage in the event of a discharge.

Watts is not responsible for the failure of alerts due to connectivity issues, power outages, or improper installation.

### NOTICE

The information contained herein is not intended to replace the full product installation and safety information available or the experience of a trained product installer. You are required to thoroughly read all installation instructions and product safety information before beginning the installation of this product.

Inquire with governing authorities for local installation requirements.

Watts product specifications in U.S. customary units and metric are approximate and are provided for reference only. For precise measurements, please contact Watts Technical Service. Watts reserves the right to change or modify product design, construction, specifications, or materials without prior notice and without incurring any obligation to make such changes and modifications on Watts products previously or subsequently sold.



## Specification

The Reduced Pressure Detector assembly shall consist of two independent torsion spring check modules, a differential pressure relief valve located between and below the two modules, two drip tight shutoff valves, and required torsion spring check modules and relief valve shall be contained within a sleeve accessible single housing constructed from 304 (Schedule 40) stainless steel pipe with groove end connections. Torsion spring checks shall have reversible elastomer discs and in operation produce drip tight closure against reverse flow caused by backpressure or backsiphonage. The bypass line shall include a meter, small diameter reduced pressure zone assembly and isolation valves. The assembly shall be Watts Series 957RPDA, and shall include a sensor on the relief valve for flood detection.

## Model/Option

FS	Sensor on relief valve for flood detection
OSY	UL Classified and FM Approved outside stem and yoke, resilient seated gate valves
N	N-pattern orientation
Z	Z-pattern orientation
BFG	UL Classified and FM Approved grooved gear operated butterfly valves with tamper switch
OSY FxG**	Flanged inlet gate connection and grooved outlet gate connection
OSY GxF**	Grooved inlet gate connection and flanged outlet gate connection
OSY GxG**	Grooved inlet gate connection and grooved outlet gate connection

## Approvals

- Approved by the Foundation for Cross-Connection Control and Hydraulic Research at The University of Southern California (FCCCHR-USC), excluding 10" N-pattern installation as well as 6" and 10" Z-pattern installations
- AWWA C511-97



1047



B64.4



(\*\*BFG & OSY Only)



Approved

## Materials

Housing & Sleeve	304 (Schedule 40) stainless steel
Elastomers	EPDM, silicone, and Buna 'N'
Torsion Spring Checks	Noryl®, stainless steel
Check Discs	Reversible silicone or EPDM
Test Cocks	Lead Free* bronze body
Pins & Fasteners	300 Series stainless steel
Springs	Stainless steel

## Pressure — Temperature

Temperature Range	33°F – 140°F (0.5°C – 60°C)
Maximum Working Pressure	175 psi (12.1 bar)

\*\*Options for the gate valve:

- Consult factory for dimensions.
- Available with grooved NRS gate valves; consult factory.
- Post indicator plate and operating nut available; consult factory.

Noryl® is a registered trademark of SHPP Global Technologies B.V.

## Dimensions – Weight

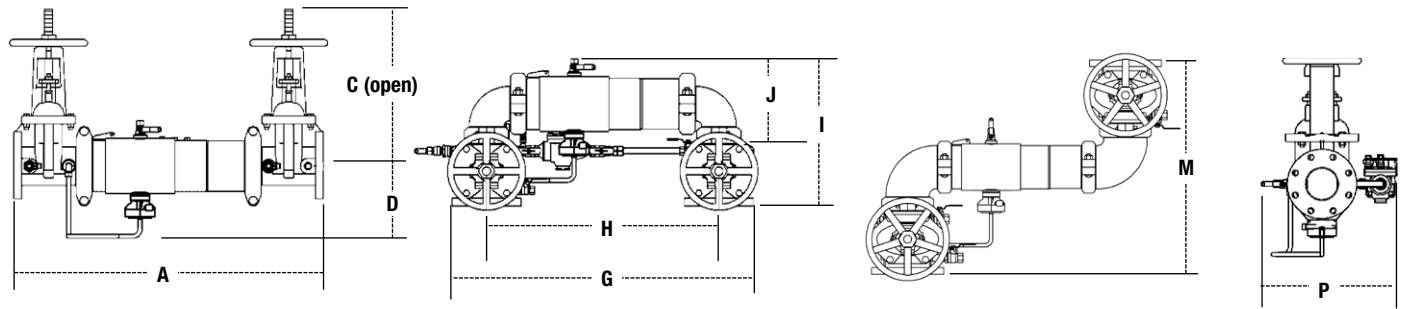

### 957RPDA, 957NRPDA, 957ZRPDA

SIZE		DIMENSIONS														WEIGHT							
in.	mm	A		C (OSY)		D		G		H		I		J		M		P		957RPDA		957NRPDA	
in.	mm	in.	mm	in.	mm	in.	mm	in.	mm	in.	mm	in.	mm	in.	mm	in.	mm	in.	mm	lb	kg	lb	kg
2½	30¾	781	16⅜	416	6½	165	29⅛	738	21½	546	15½	393	8⅓	223	21¼	540	13⅜	335	142	64	150	68	
3	31¾	806	18⅞	479	6⅞	170	30¼	768	22¼	565	17⅞	435	9⅞	233	23	584	14½	368	162	73	175	79	
4	33¾	857	22¼	578	7	178	33	838	23½	597	18½	470	9⅞	252	26¼	667	15⅜	386	178	81	201	91	
6	43½	1105	30⅞	765	8½	216	44¾	1137	33¾	845	23⅜	589	13⅜	332	32¼	819	19	483	312	142	353	160	
8	49¾	1264	37¾	959	9⅞	246	54⅞	1375	40⅞	1019	27⅞	697	15⅞	399	36⅞	937	21⅜	538	497	225	572		
10	57¾	1467	45¾	1162	23⅞	605	8⅞	208	66	1676	49⅞	1257	32½	826	17⅞	440	20	508	721	327	781	354	

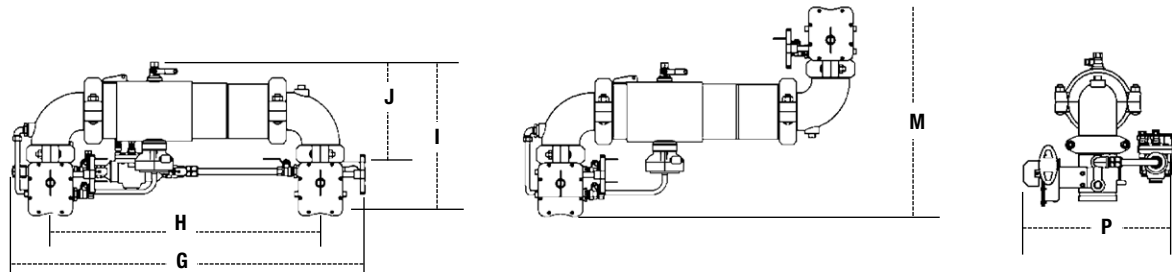

### 957NRPDABFG, 957ZRPDABFG

SIZE	DIMENSIONS										WEIGHT			
in.	G		H		I		J		M		P		957RPDABFG	
in.	in.	mm	in.	mm	in.	mm	in.	mm	in.	mm	in.	mm	lb	kg
2½	32½	826	23	584	15½	394	9½	241	19¼	502	15⅞	402	81	37
3	34	864	24	610	16⅞	414	10⅞	256	21¼	540	16⅞	410	84	38
4	35⅞	905	25½	648	17⅞	437	10⅞	279	23½	597	16⅞	422	101	46
6	46½	1181	35¼	895	20½	521	13½	343	27¼	692	19	483	174	79

# Capacity

Flow curves as tested by Underwriters Laboratories.

Flow characteristics collected using butterfly shutoff valves.

\_\_\_\_\_ Horizontal
\_\_\_\_\_ N-Pattern
\_\_\_\_\_ Z-Pattern

Flow capacity chart identifies valve performance based upon rated water velocity up to 25 fps.

- Service Flow is typically determined by a rated velocity of 7.5 fps based upon Schedule 40 pipe.
- Rated Flow identifies maximum continuous duty performance determined by AWWA.
- UL Flow Rate is 150% of Rated Flow and is not recommended for continuous duty.
- AWWA Manual M22 (Appendix C) recommends that the maximum water velocity in services be not more than 10 fps.

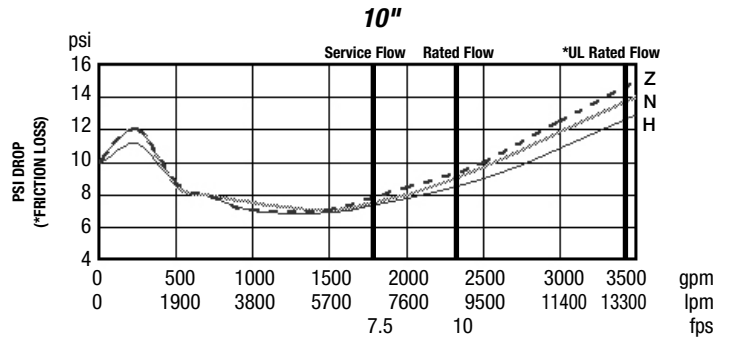
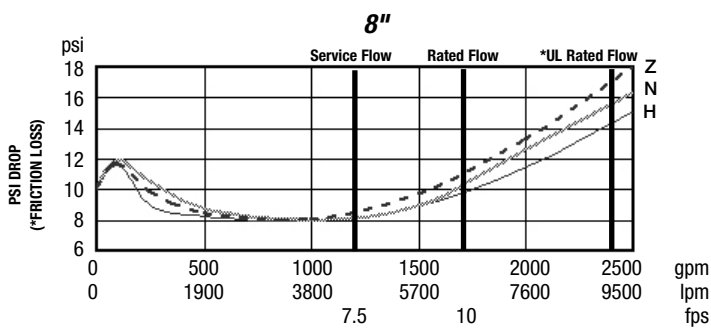
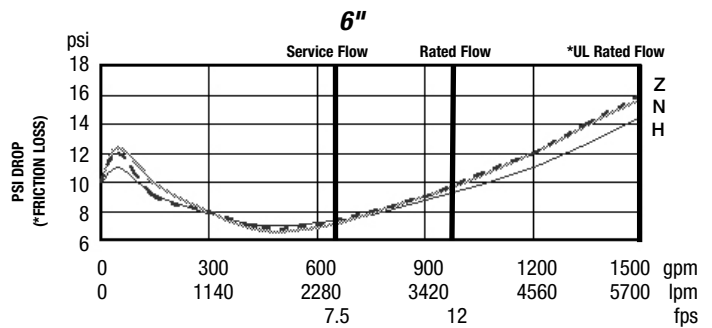
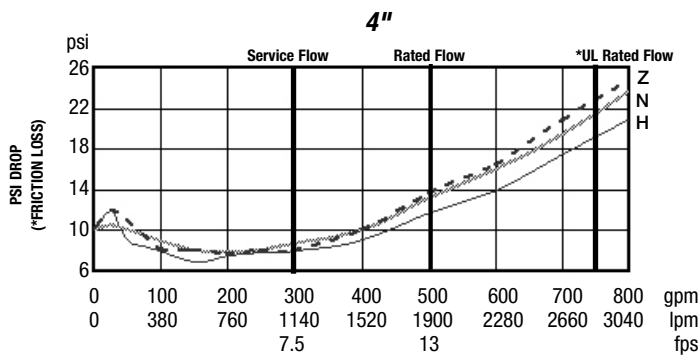
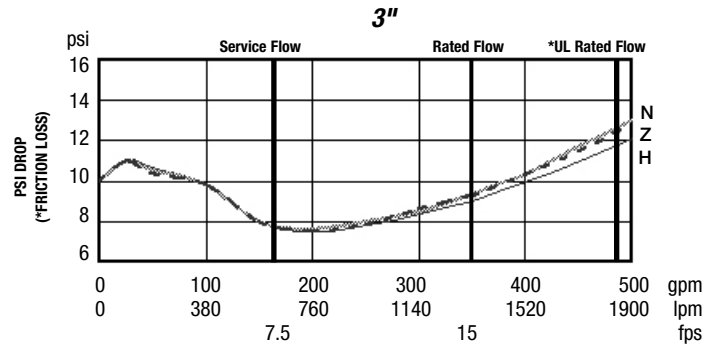
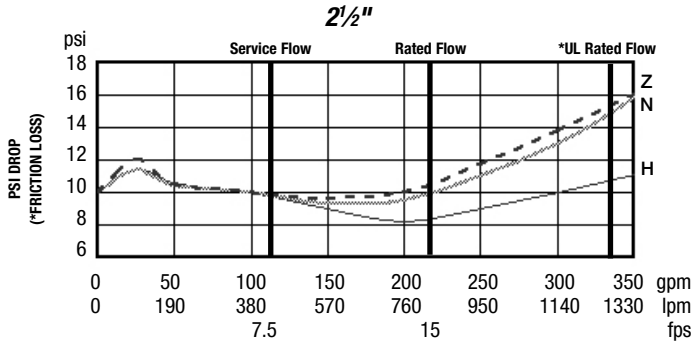

**USA:** T: (978) 689-6066 • Watts.com  
**Canada:** T: (888) 208-8927 • Watts.ca  
**Latin America:** T: (62) 55-4122-0138 • Watts.com