

Installation, Operation and Maintenance Manual

tekmarNet® Gateway 486



The tekmarNet® Gateway allows remote access to a tekmarNet® HVAC system. Users can view and change settings for each thermostat, including: temperature, heat/cool/auto, fan operation, relative humidity, schedules, and the away scene. In addition, the boiler system temperatures, firing rate, run times, and pump status can be viewed. All system data can be graphed on a chart or exported as a CSV file. Users are informed of errors and warnings through email or text notifications. The 486 includes three alert inputs that can be used to monitor auxiliary equipment.

This Operation Manual provides in-depth operation and troubleshooting details. For assistance, contact your local tekmar representative: <https://www.watts.com/how-to-buy-sales-representative>. Or call tekmar® customer service at 1-800-438-3903.

Table of Contents

Important Safety Information	3	tekmarNet Web and Mobile Apps	18
Radio Frequency Interference	4	Legal	18
Included in the Box	4	Mobile App Download.....	18
Tools Required.....	4	Website	18
Materials Required	4	Create Account	18
Networking Requirements.....	4	Login	19
Web Browser Requirements.....	4	Add a Building.....	19
Mobile App Requirements.....	4	Registration Code	20
Compatibility	5	Buildings List.....	21
Physical Dimensions	5	Buildings Map	21
Installation Location	5	Edit or Remove Building	21
Mounting	6	Access Levels	22
Thermostat Addressing	6	Building Users.....	22
Wiring	7	Adding a User	22
tekmarNet® Bus	7	Edit or Remove a User from a Building.....	23
Alert Inputs.....	7	Editing or Delete My Account Settings.....	23
SD Card.....	7	Thermostat List	24
Ethernet.....	7	Thermostat Floor Plan.....	24
Power	7	Thermostat Temperature.....	25
Wiring to Switching Relays 301P, 304P, 306P and		Thermostat Floor Temperature.....	25
Zone Valve Controls 304V, 306V	8	Thermostat Relative Humidity.....	25
Wiring to House Controls 400, 401, 402, 403, 406....	9	Thermostat Fan.....	26
Wiring to tN4 Universal Reset Module 423 and 335...	10	Thermostat Settings.....	26
Wiring to Boiler Controls 274 and 275.....	11	Thermostat Schedule.....	26
Wiring to Boiler Control 284.....	12	Thermostat Graphing	27
Gateway User Interface.....	13	Hydronic System Overview.....	27
Home Screen	13	Hydronic System Schematic.....	27
Symbols	13	Hydronic System Settings.....	28
Menu Selection	14	Hydronic System Control Graphing	28
Internet Menu.....	14	Error Message History	29
tekmarNet Menu	15	Error Message Description.....	29
Time Menu	16	Custom Error Message for Alert Inputs	29
Toolbox Menu.....	16	Troubleshooting FAQ.....	30
Error Notification on Home Screen	17	Technical Data	31
Error History in Toolbox Menu.....	17	Warranty	32

▲ WARNING



Read this Manual BEFORE using this equipment.

Failure to read and follow all safety and use information can result in death, serious personal injury, property damage, or damage to the equipment.

Keep this Manual available for easy access by all users. Replacement Manuals are available at tekmarControls.com

Important Safety Information



This is a safety-alert symbol. The safety alert symbol is shown alone or used with a signal word (DANGER, WARNING, or CAUTION), a pictorial and/or a safety message to identify hazards.

When you see this symbol alone or with a signal word on your equipment or in this Manual, be alert to the potential for death or serious personal injury.



This pictorial alerts you to electricity, electrocution, and shock hazards.

▲ WARNING

This symbol identifies hazards which, if not avoided, could result in death or serious injury.

▲ CAUTION

This symbol identifies hazards which, if not avoided, could result in minor or moderate injury.

NOTICE

This symbol identifies practices, actions, or failure to act which could result in property damage or damage to the equipment.

▲ WARNING

To avoid serious personal injury and damage to the equipment:

- Do not use unless you know the safe and proper operation of this equipment.
- Improper installation and operation of this control could result in damage to the equipment and possibly even personal injury or death.
- This electronic control is not intended for use as a primary limit control. Other controls that are intended and certified as safety limits must be placed into the control circuit.

NOTICE

- Do not attempt to service the control. There are no user serviceable parts inside the control. Attempting to do so voids warranty.
- It is your responsibility to ensure that this control is safely installed according to all applicable codes and standards. tekmar is not responsible for damages resulting from improper installation and/or maintenance.

▲ WARNING

Installation must be performed by qualified persons, in accordance with local codes, ANSI/NFPA 70 (NEC Article 424) and CEC Part 1 Section 62 where applicable. Prior to installation, please consult the local codes in order to understand what is acceptable. To the extent this information is not consistent with local codes, the local codes should be followed. Please be aware local codes may require this product and/or the control to be installed by an electrician.

Radio Frequency Interference

This equipment has been tested and found to comply with the limits for a Class B digital device, pursuant to part 15 of the FCC Rules. These limits are designed to provide reasonable protection against harmful interference in a residential installation. This equipment generates, uses and can radiate radio frequency energy and, if not installed and used in accordance with the instructions, may cause harmful interference to radio communications. However, there is no guarantee that interference will not occur in a particular installation. If this equipment does cause harmful interference to radio or television reception, which can be determined by turning the equipment off and on, the user is encouraged to try to correct the interference by one or more of the following measures:

Reorient or relocate the receiving antenna.

Increase the separation between the equipment and receiver.

Connect the equipment into an outlet on a circuit different from that to which the receiver is connected.

Consult the dealer or an experienced radio/TV technician for help

Cet appareil numérique de la classe B respecte toutes les exigences du Règlement sur le matériel brouilleur du Canada.

Included in the Box

- tekmarNet® Gateway 486
- Wall plug power supply
- Screwdriver
- IOM Manual IOM-T-486

Tools Required

- Phillips head screwdriver
- Needle-nose pliers
- Wire stripper

Materials Required

- Two conductor 18 AWG Low Voltage Thermostat LVT solid core wire
- Four wood screws

Networking Requirements

The 486 must connect to a router that is connected to a broadband Internet Service Provider. Cellular, satellite and dial-up Internet services may not have enough speed and are not recommended.

Web Browser Requirements

The 486 supports the latest versions of the following web browsers:

- Chrome™ by Google LLC.
- Firefox® by the Mozilla Foundation.
- Safari® by Apple Inc.
- Microsoft Edge by Microsoft Corporation.

NOTICE

Internet Explorer 11 is not supported and an alternate web browser is required to access the tekmarNet web app.

Mobile App Requirements

The tekmarNet mobile app is available as a free download from the App Store® online store or Google Play™ store and is compatible with Apple® iOS version 12 and Android™ version 10 and later.

Apple and App Store are trademarks of Apple Inc., and Google Play and Android are trademarks of Google LLC.

NOTICE

Before using the Internet connected features of this product, you must accept the Terms of Use, as amended from time to time and available at <https://www.watts.com/terms-of-use>.

Compatibility

The 486 has been tested to be compatible with the following tekmarNet products:

- tekmarNet®4 Setpoint Control 161, 162
- Boiler Control 274, 275, 284
- Smart Boiler Control 294
- tN2 Wiring Center 313, 314
- tN4 Wiring Center 315, 316
- Zone Expansion Module 324, 325, 326
- Zone Manager 334, 335, 336, 337
- Power Manager 345, 346
- tN2 House Control 400, 401, 402, 403, 406
- Boiler Reset Module 420
- Universal Reset Module 422, 423
- Mixing Expansion Module 440, 441, 444
- tN4 User Switch 479, 480, 481
- tekmarNet® Thermostat 532, 552, 553, 554, 557
- Snow Melt Control 654, 670, 671

Physical Dimensions

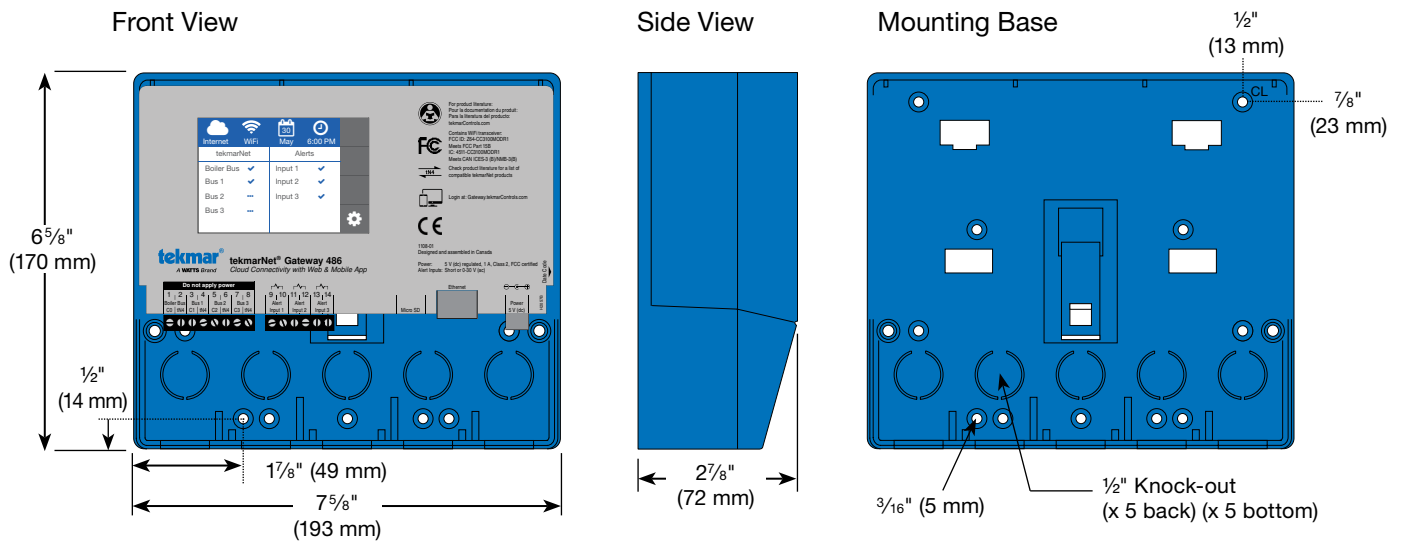

Installation Location

When choosing the location for the control, consider the following:

- Interior wall.
- Keep dry. Avoid potential leakage onto the control.
- Relative humidity less than 90%. Non-condensing environment.
- No exposure to extreme temperatures beyond 32 to 122°F (0 to 50°C).
- Away from equipment, appliances, or other sources of electrical interference.
- Easy access for wiring, viewing.
- Approximately 5 feet (1.5 m) off the finished floor.
- The maximum length of wire is 500 feet (150 m).
- Strip wire to 3/8" (10 mm) for all terminal connections.
- Use standard 18 AWG wire.
- Ethernet cable maximum length is 328 feet (100 m).
- WiFi maximum distance is 100 feet (30 m) line of sight with no walls. Walls reduce WiFi range.

Mounting

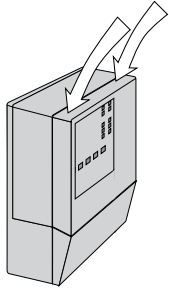

Press down at the fingertip grips on top of the front cover and pull out and down.

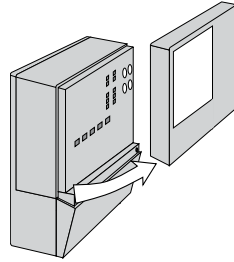

Lift the front cover up and away from the control.

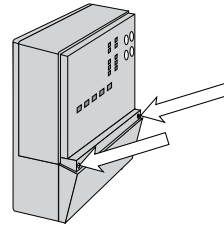

Loosen the screws at the front of the wiring cover.

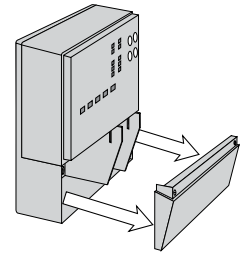

The wiring cover pulls straight out from the wiring chamber.

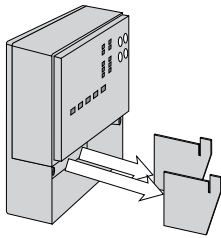

Remove the safety dividers from the wiring chamber by pulling them straight out of their grooves.

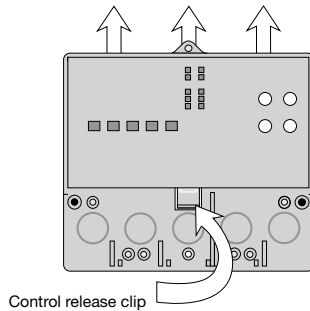

Press the control release clip on the base inside the wiring chamber and slide the control upwards.

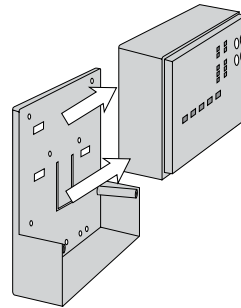

The control lifts up and away from the base.

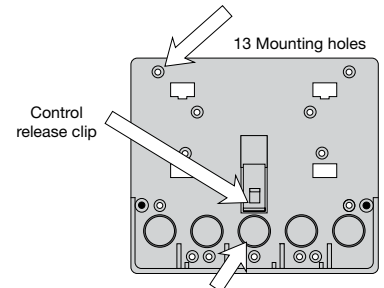

Control release clip

13 Mounting holes

There are 10 conduit knock-outs at the back and bottom of the wiring chamber.

The base is ready for mounting.

The control can be mounted on a standard DIN rail (sold separately, part M9303). First remove the control from its base and then, using the hooks and spring clip on the back of the control, mount it onto the DIN rail. This will be a popular option for those who prefer to mount the control inside a larger electrical panel.

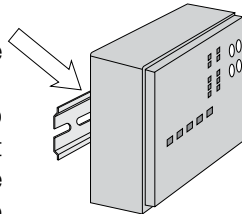

The wiring can enter the bottom or the back of the enclosure. Knock-outs provided in the base allow the wiring to be run in conduit up to the enclosure. The base also has holes that line up with the mounting holes of most common electrical boxes.

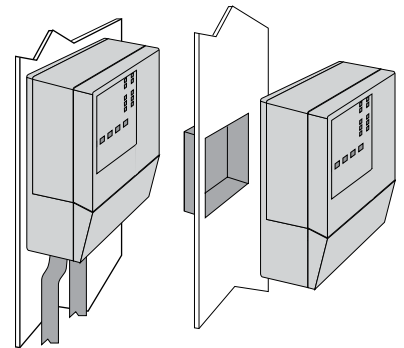

Thermostat Addressing

Before connecting the tekmarNet® Gateway 486 to a tekmarNet® system, it is recommended that the system be fully completed, with no tekmarNet® thermostats or setpoint controls being added or removed at a later date. Also, each tekmarNet® thermostat and setpoint control device is automatically assigned a tekmarNet® address when connected to the system. It is recommended that each device be given a manual address. This address should be written down together with the room location for future reference.

The gateway records the address of each tekmarNet® thermostat and setpoint control. The mobile and web app allows the installer to name the room location and building area for each thermostat and setpoint control based upon its tekmarNet® address.

Wiring

⚠ WARNING



Disconnect all power before opening the control.

To prevent the risk of personal injury and/or death, make sure power is not applied to the product until it is fully installed and ready for final testing. All work must be done with power turned off to the circuit being worked on.

tekmarNet® Bus

The 486 includes four tekmarNet® bus inputs. The tN4 bus inputs allow communication between the 486 and the tekmarNet® system. Each tN4 bus on the tekmarNet® system must be wired to the tN4 bus inputs on the 486. The tN4 bus may be wired before or after the control is powered on and setup.

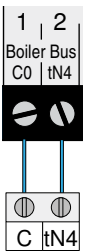

NOTICE

All available tN4 buses must be wired to the 486 whether or not there are thermostats connected to the bus.

Alert Inputs

The 486 includes three alert inputs, each of which trigger a notification alert. The alert notification message can be customized through the web app.

The alert can be triggered when a switch is closed or powered with 24 V (ac). To select this option, go to the Toolbox menu > Alert Inputs and set to Normally Open.

The alert can also be triggered when a switch is opened or power is removed when the Alert Input is set to Normally Closed.

Examples of how to use the alert inputs to monitor heating equipment problems include:

- Low water cut off
- Heating oil or propane tank low tank level
- Boiler flame failure lockout
- Loss of equipment power



Alert Inputs	
Alert 1	Normally Open
Alert 2	Normally Closed
Alert 3	Normally Open

SD Card

The 486 includes a SD Card. This is used to store historical data for graphing and error history. Removal of the SD card creates an error message and the 486 is unable to record or display historical information.

Ethernet

The 486 may be connected to a router using Ethernet using Category 5e cabling.

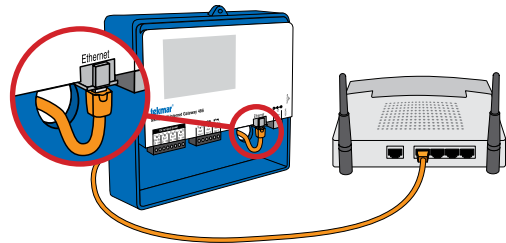

Power

The 486 includes a wall plug power supply with a 6 ft. cable.

- Connect the small round end into the power receptacle on the 486.
- Plug the wall plug into a 120 V (ac) power receptacle.
- The 486 display will turn on.

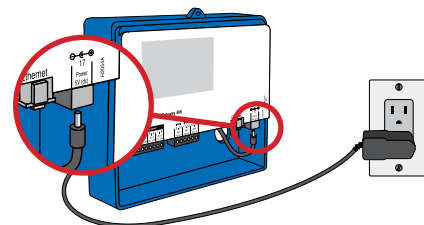

Wiring to Switching Relays 301P, 304P, 306P and Zone Valve Controls 304V, 306V

NOTICE

- Requires the installation of tekmarNet thermostats with the Switching Relay or Zone Valve Control.
- This creates a thermostat only network that is limited to one tekmarNet bus and a maximum of 24 devices.

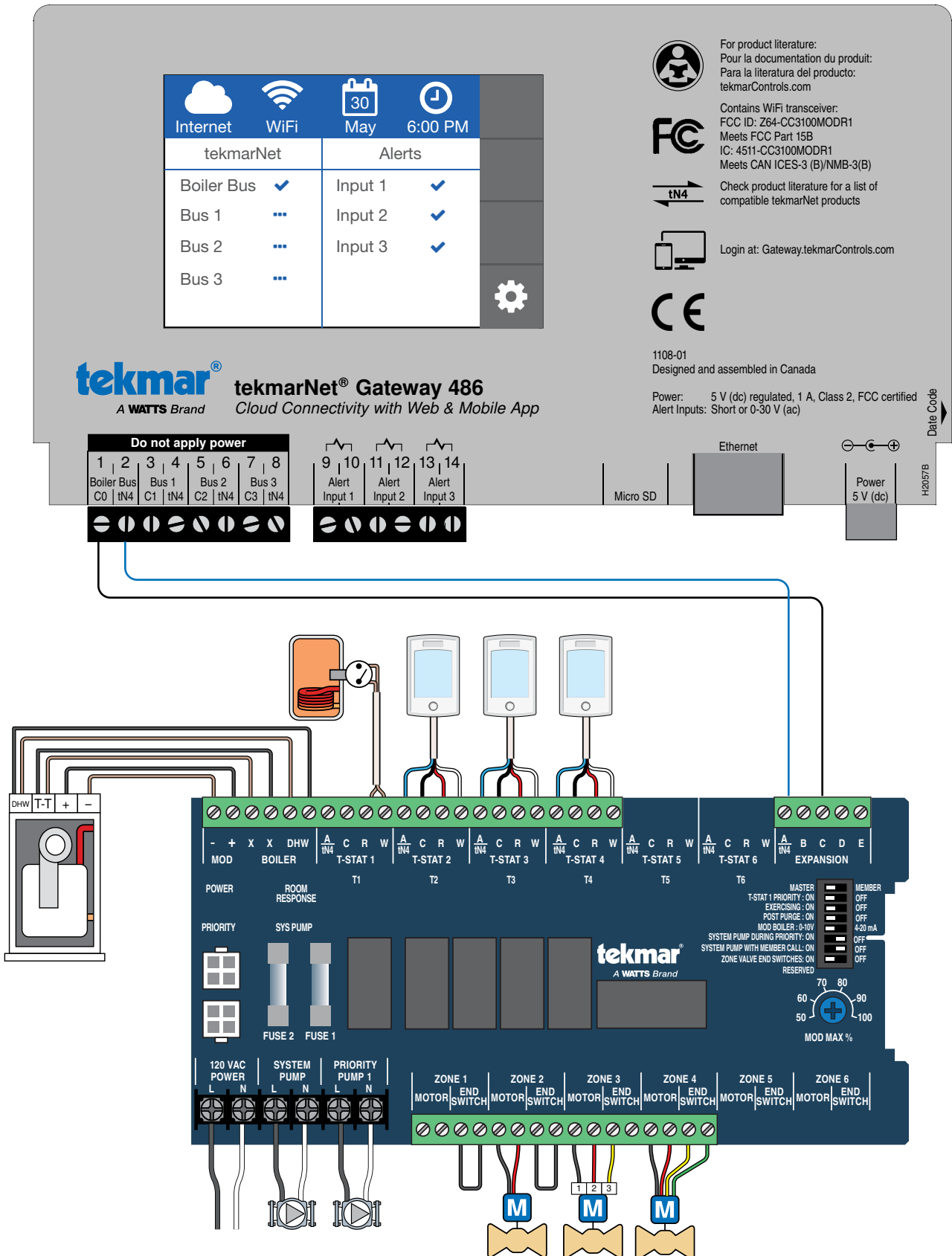

Wiring to House Controls 400, 401, 402, 403, 406

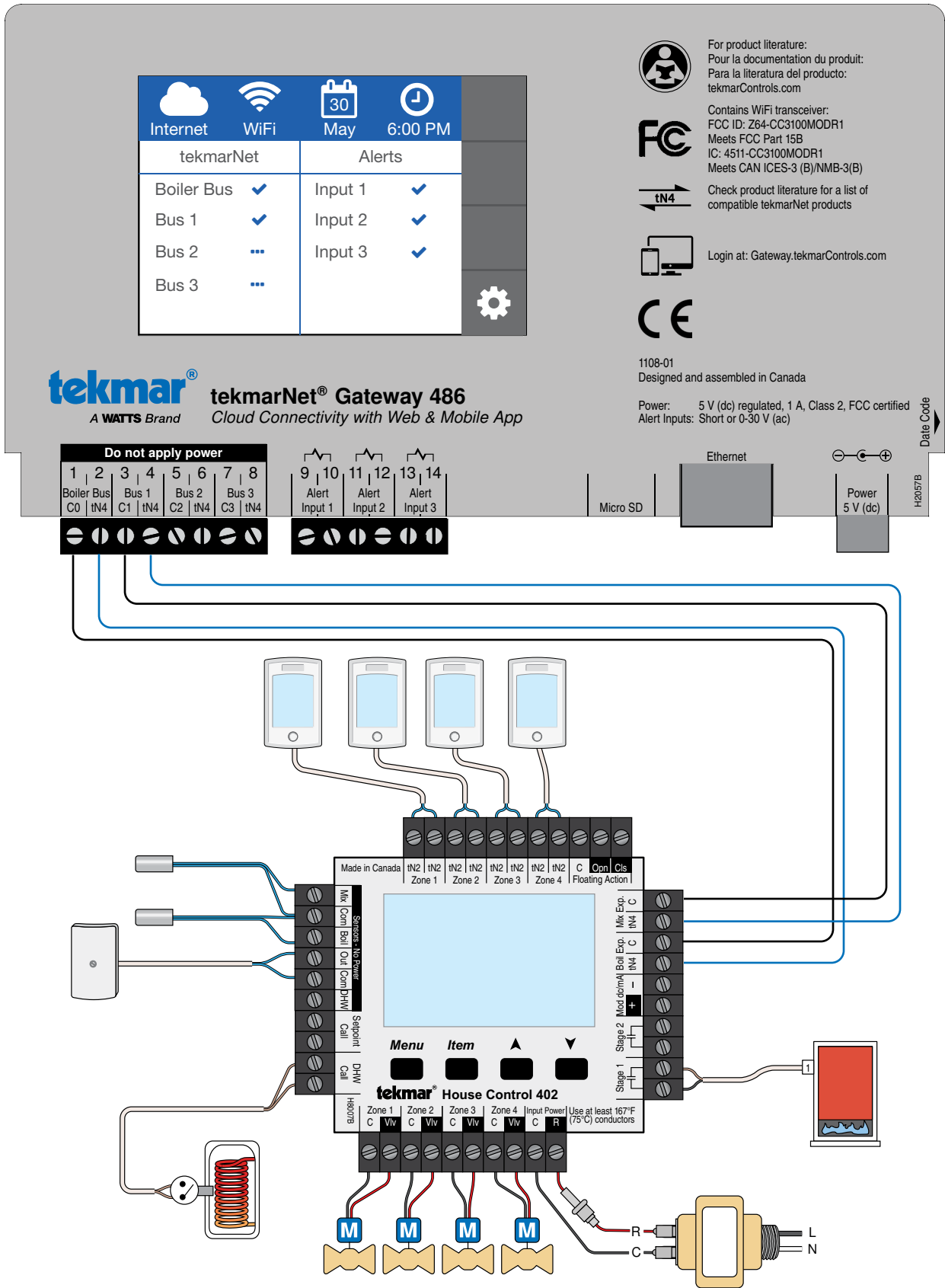

Wiring to tN4 Universal Reset Module 423 and 335

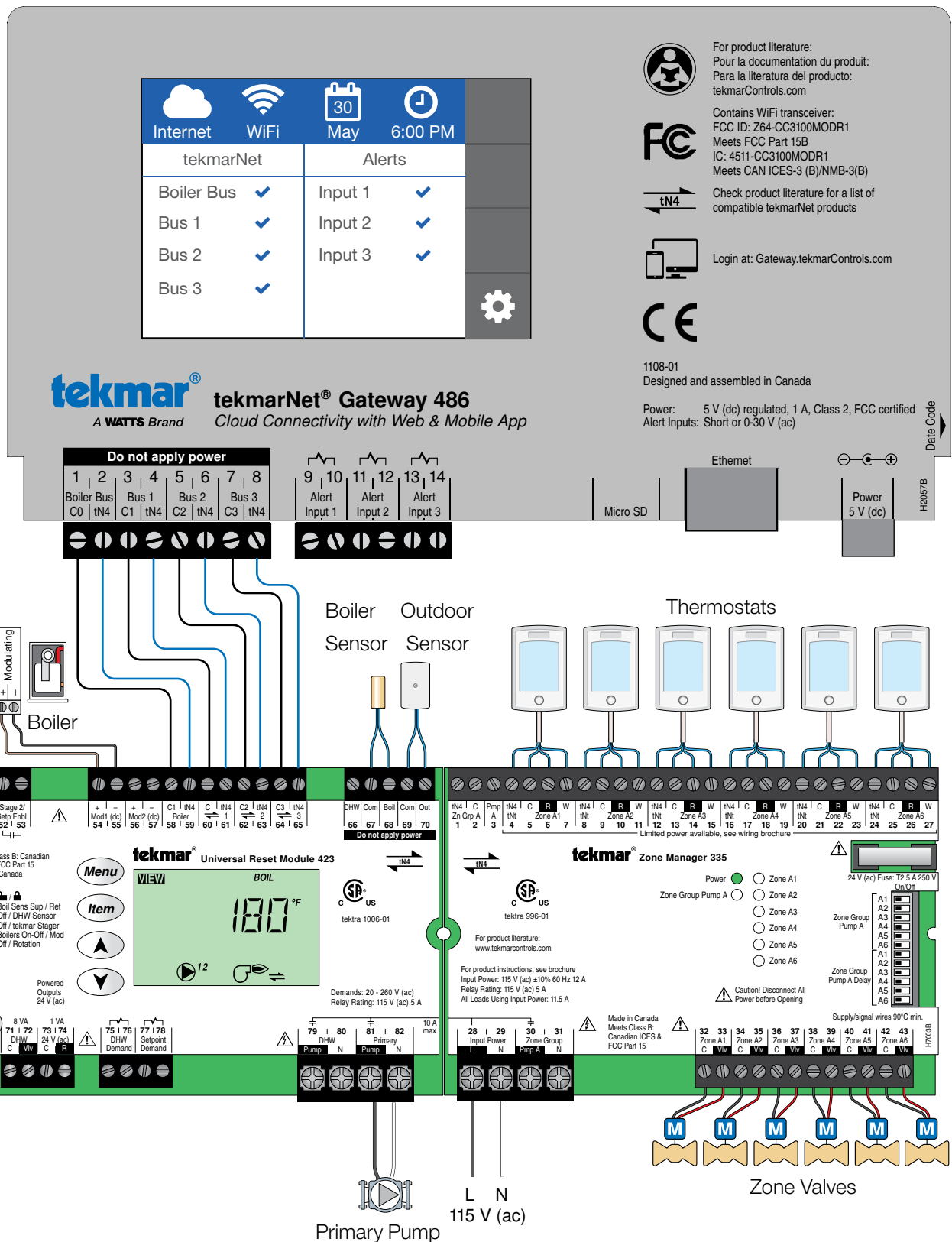

Wiring to Boiler Controls 274 and 275

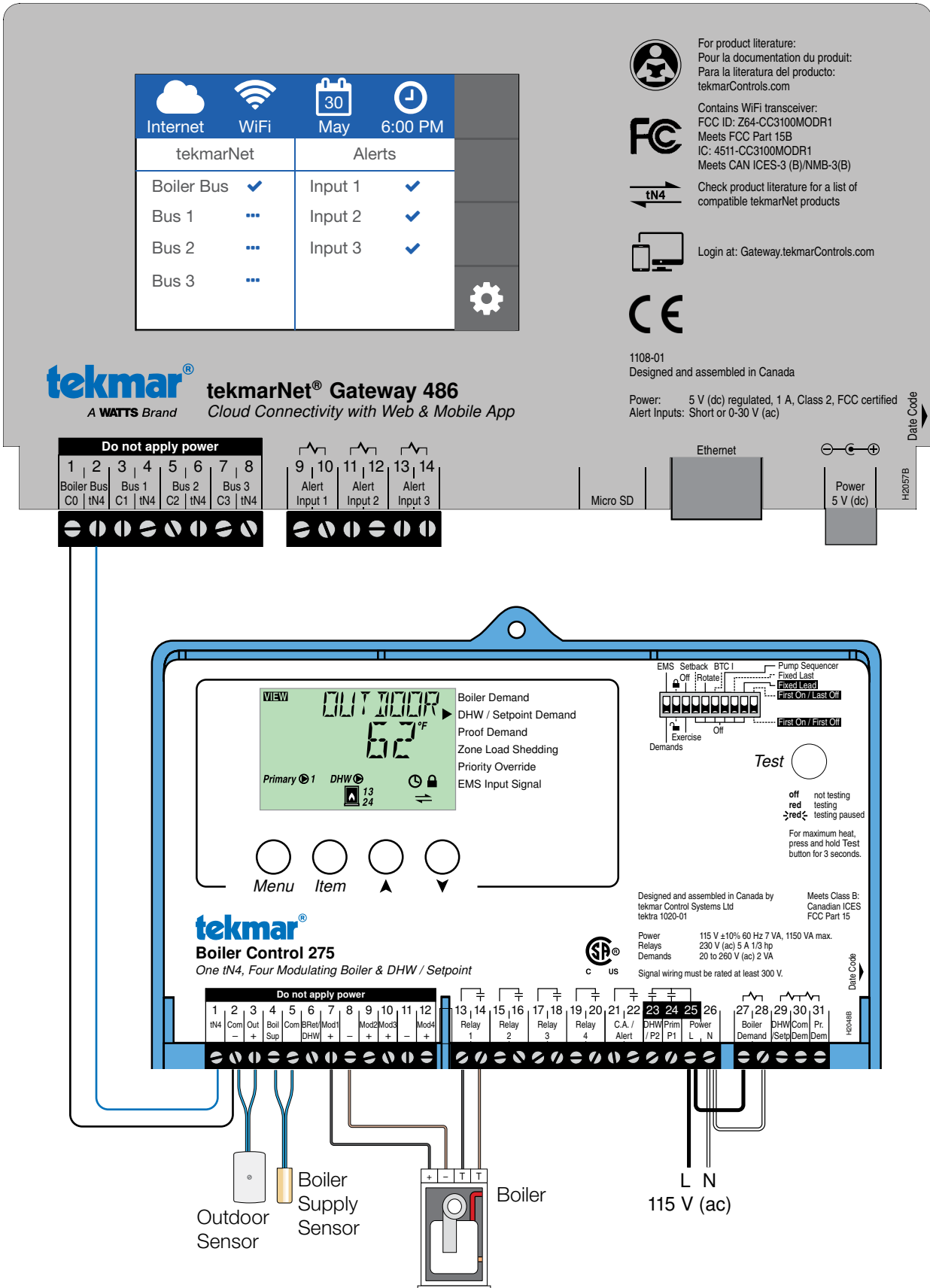

Wiring to Boiler Control 284

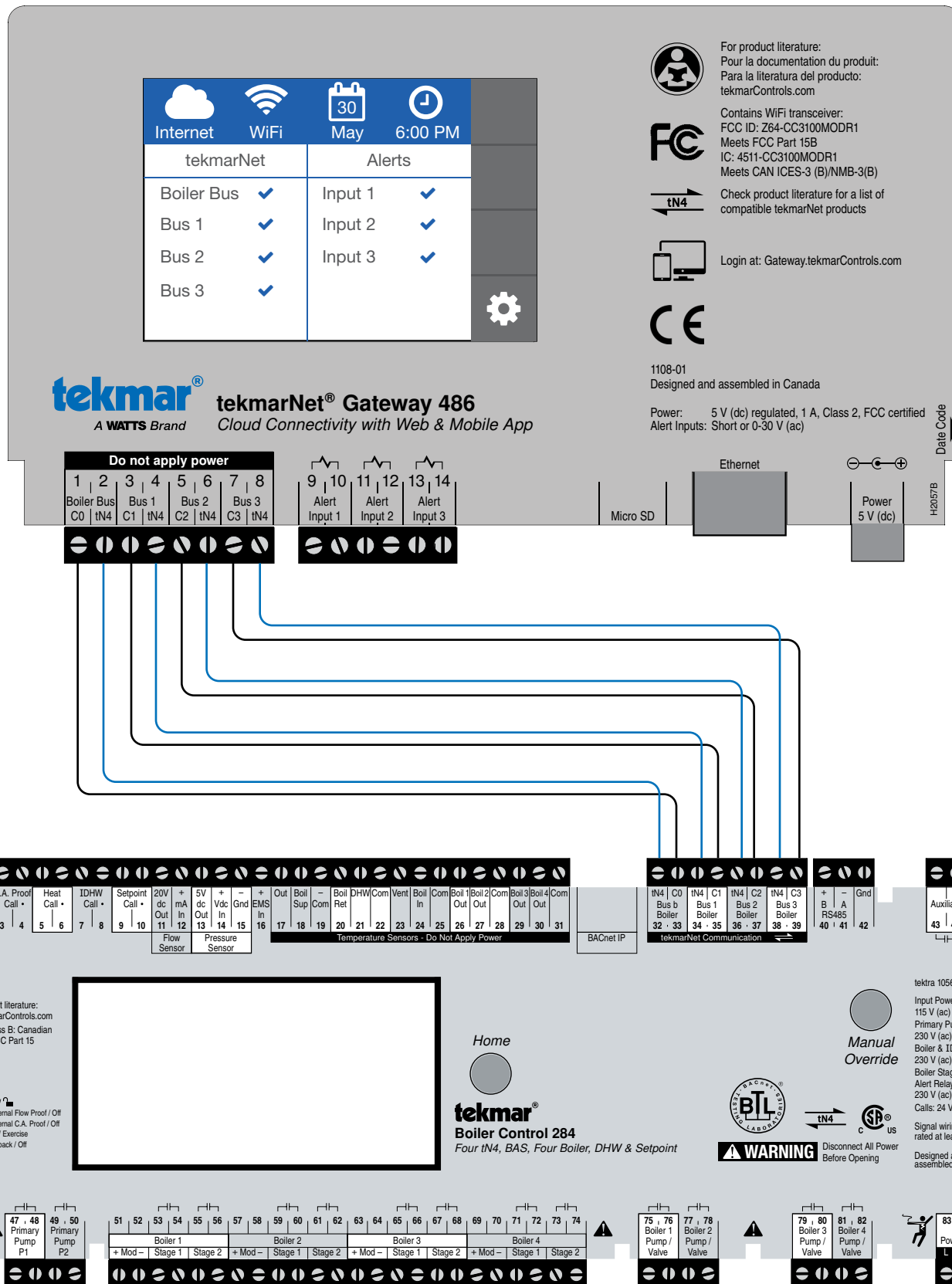

Gateway User Interface

Home Screen

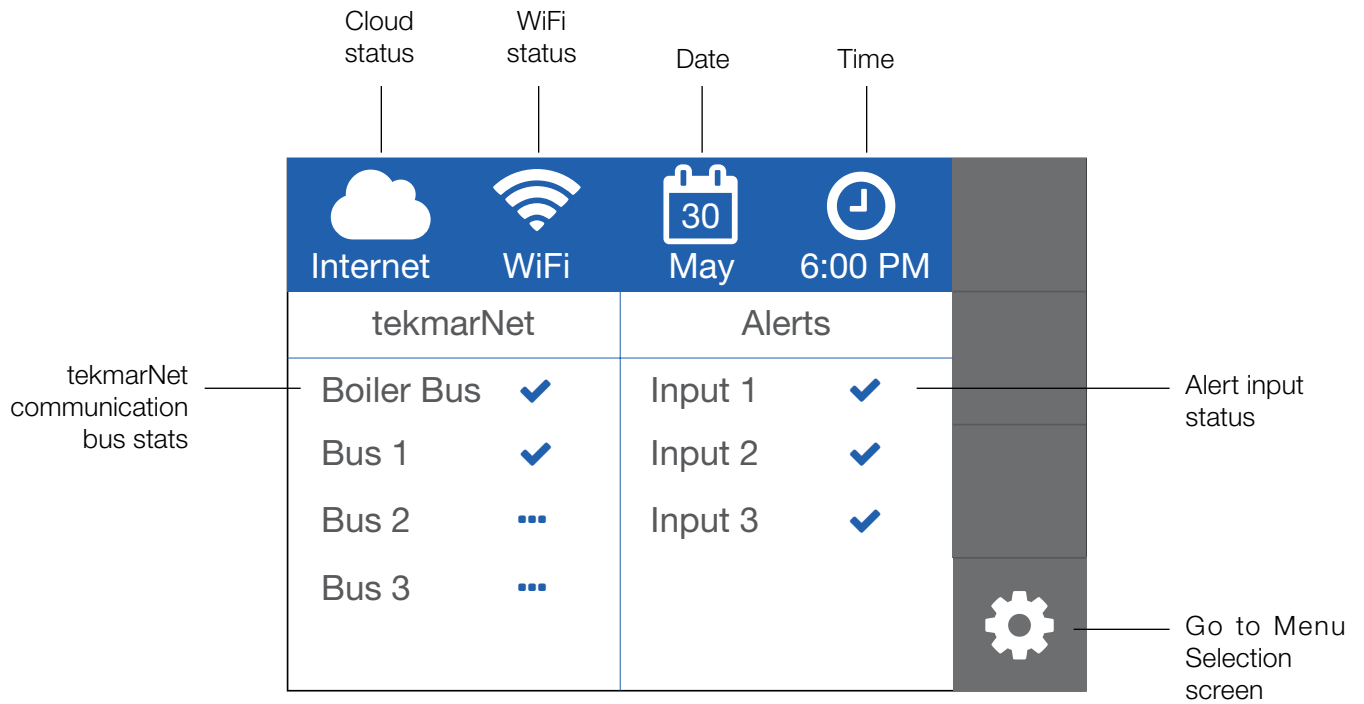

Symbols



Connected to the cloud



Connected to WiFi



Disconnected from
Cloud, WiFi or
tekmarNet



Today's date



Current time



Error



tN4 is connected
No Alert



Save and back to
previous screen



Go to Menu Selection
screen

Menu Selection

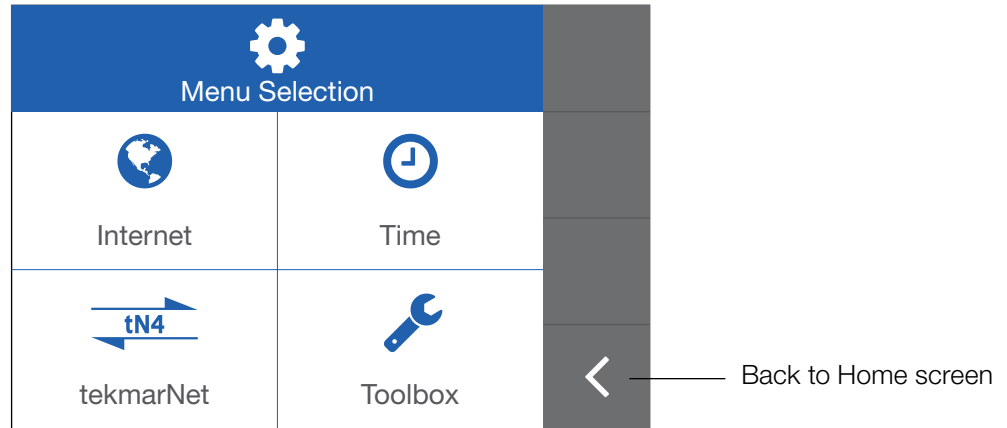

The 486 has four settings menus: Internet, Time, tekmarNet, and Toolbox.

Internet Menu

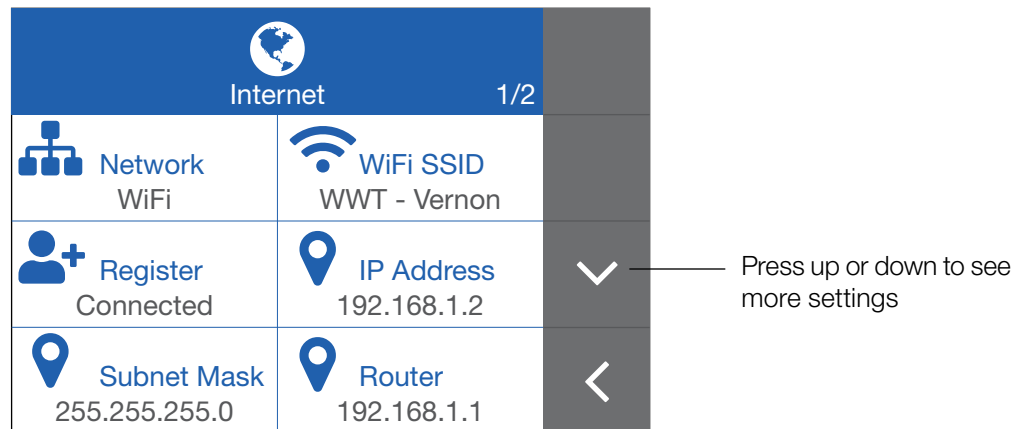

Setting	Range	Default	Conditions
Network	Ethernet or WiFi	Ethernet	Always available
WiFi SSID	Scans for available WiFi SSIDs	Not applicable	Always available
Register	Provides 8-digit registration code	Not applicable	Always available
IP Address	0.0.0.0 to 255.255.255.255	192.168.1.2	Configure IP is set to Static, Installer access level
Subnet Mask	0.0.0.0 to 255.255.255.255	255.255.255.0	Configure IP is set to Static, Installer access level
Router	0.0.0.0 to 255.255.255.255	192.168.1.1	Configure IP is set to Static, Installer access level
DNS 1	0.0.0.0 to 255.255.255.255	8.8.8.8	Configure IP is set to Static, Installer access level
DNS 2	0.0.0.0 to 255.255.255.255	9.9.9.9	Configure IP is set to Static, Installer access level
Configure IP	DHCP or Static	DHCP (automatic)	Installer access level

tekmarNet Menu

tN4 tekmarNet	
Boiler Bus 0 Devices	Bus 1 0 Devices
Bus 2 0 Devices	Bus 3 0 Devices

- The tekmarNet menu is only available when the 486 is set to **Installer** access level. Go to the Toolbox menu to change.
- The tekmarNet menu displays the number of devices (thermostats, setpoint controls, snow melt controls, boiler controls and timers) connected to each tekmarNet communication bus.
- Touching the Boiler Bus, Bus 1, Bus 2 or Bus 3 button displays a list of all potential 25 devices on the bus.
- A network that includes a boiler control (tN4 System Control) may have up to 4 tekmarNet buses with a maximum of 96 devices.
- A thermostat only network is limited to a single tekmarNet bus and 24 devices.

tN4 Boiler Bus					Remove All
b:Mstr 284	b:01 557	b:02 552	b:03 552	b:04 552	
b:05 552	b:06 552	b:07 552	b:08 552	b:09 552	
b:10 552	b:11 552	b:12 552	b:13 552	b:14 552	
b:15 552	b:16 552	b:17 552	b:18 552	b:19 552	
b:20 552	b:21 552	b:22 552	b:23 162	b:24 670	

The bus menu displays the entire list of devices connected to the 486. The button turns blue when there is communication to the device. Touch an address Mstr (boiler control) or 1 through 24 to view the device information.

Remove thermostat from list

b:Mstr			Remove
Status	Boiler 1	Boiler 2	
Model 284	Outlet ---	Outlet ---	
Ver J1220J	Inlet ---	Inlet ---	
Usage 29%	Output100%	Output100%	
	Pump On	Pump On	
System	Boiler 3	Boiler 4	
Target 165°	Outlet ---	Outlet ---	
Supply 155°	Inlet ---	Inlet ---	
Return 145°	Output100%	Output100%	
Output100%	Pump On	Pump On	

b:01			Remove
Status	Temperature	Targets	
Model 557	Air 70°	Heat 70°	
Ver J1284I	Floor 80°	Cool 75°	
Usage 1%	WWSD Off	Floor 75°	
Schedule	Air	Humidity	
Event Occ	Group 1	RH 40%	
Mode Zone	Fan 80%	Min 20%	
Over None		Max 60%	

- This displays the boiler control's information.
- Press "REMOVE" to remove the boiler control from the 486's device list.

- This displays the thermostat's information.
- Press "REMOVE" to remove the thermostat from the 486's device list.

Time Menu

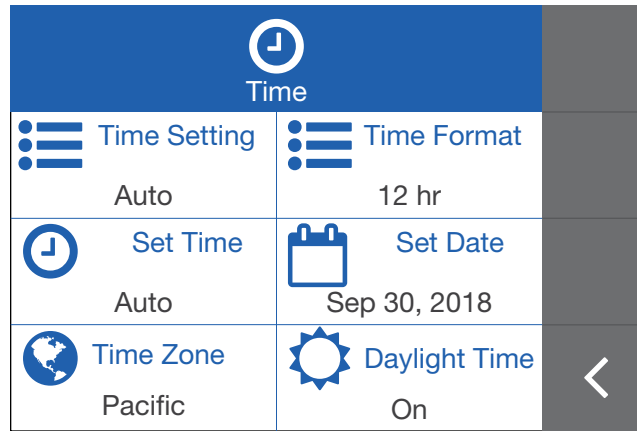

Setting	Range	Default	Conditions
Time Setting	Auto or Manual	Auto	Always available
Time Format	12 or 24 hour	12 hr	Always available
Set Time	12:00 AM to 12:59 PM (00:00 to 23:59)	Auto	Adjustable when Set Time is Manual
Set Date	Month, Day, Year	Auto	Adjustable when Set Time is Manual
Time Zone	Newfoundland, Atlantic, Eastern, Central, Mountain, Pacific, Alaska, Hawaii, Britain	Eastern	Always available
Daylight Savings	Off or On	On	Always available

NOTICE

Incorrectly setting the time and date manually may prevent the tekmarNet Gateway 486 from communicating to the web and mobile apps. Automatic time source is recommended when using an Internet connection.

Toolbox Menu

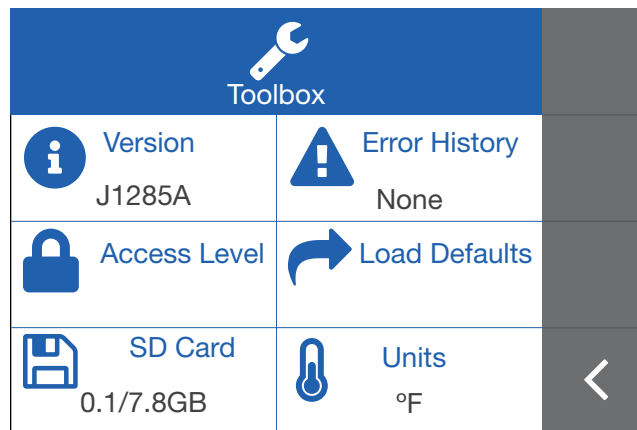

Setting	Range	Default	Conditions
Version	J1285A through Z	J1285E	Always available
Error History	List of errors	None	Always available
Access Level	User or Installer	User	Always available
Load Defaults	No or Yes	No	Installer access level
SD Card	0 to 8 GB	0 GB	Installer access level
Units	°F or °C (used in tekmarNet menu)	°F	Installer access level
Alert Inputs	Normally Open, Normally Closed	Normally Open	Installer access level

Error Notification on Home Screen

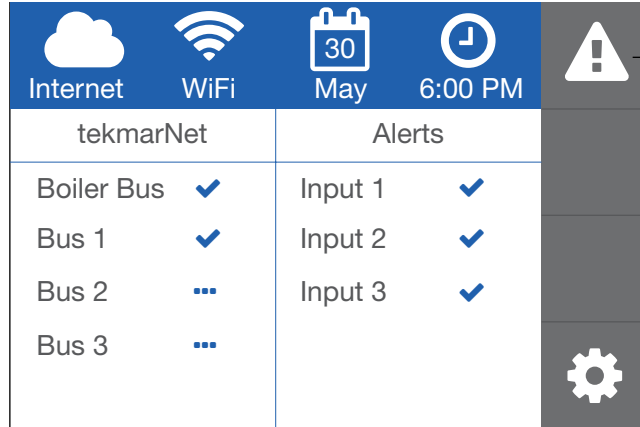

- Alert symbol displayed when an error is present
- Press Alert button to view Error History

Error History in Toolbox Menu

Error History		Clear
tN4	Mixing Supply Sensor (b:31) May 30 09:20 AM	
		←

Type of error

Errors on 486

- Cloud
- Memory
- Boiler Bus
- Bus 1
- Bus 2
- Bus 3
- Network
- SD Card
- Alert 1
- Alert 2
- Alert 3

System errors

- tN4 - error on tekmarNet® system

Clear error history

- Error message
- Time stamp when error occurred

Back to Toolbox Menu

tekmarNet Web and Mobile Apps

The tekmarNet Gateway 486 supports both mobile and web apps. The web app includes all the functionality of the mobile app plus the following:

- Building location map
- Thermostat floor plan
- Hydronic system control schematic
- Alert input error message configuration

Legal

In order to use the tekmarNet® web and mobile application, you must agree to the Watts® Terms of Use and Privacy Policy during your account registration. The Policies are available on the Watts.com website.

- <https://www.watts.com/terms-of-use>
- <https://www.watts.com/privacy-policy>

Mobile App Download

The tekmarNet mobile application supports both iOS and Android versions.

iOS: <https://apps.apple.com/us/app/tekmarNet/id1455265964>

Android: <https://play.google.com/store/apps/details?id=com.tekmarNetGateway.Gateway486MobileApp>



Website

The tekmarNet web application is available using the following URL:

<https://Gateway.tekmarControls.com>

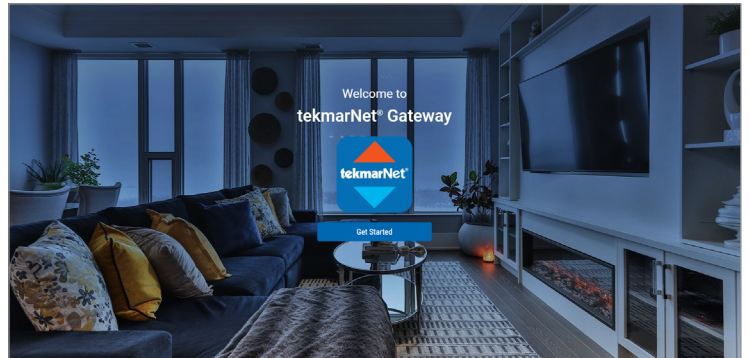

Create Account

Press "Get Started" to go to the login page.

Then press "Sign up now" and follow the steps to create an account.

You will be asked to scroll down and accept the Terms of Use and Privacy Policy.

A screenshot of the Watts login page. The page is titled "WATTS" and "Sign in with your email". It features two input fields: "Email" and "Password". Below the "Password" field is a "Forgot password? Click here" link. At the bottom, there is a "Sign in" button and a "Don't have an account? Sign up now" link. A line from the text above points to the "Sign up now" link.

Your email address is used to create your Watts account. To protect your identity, a verification code is sent your email address.

Enter the code into the form and press verify.

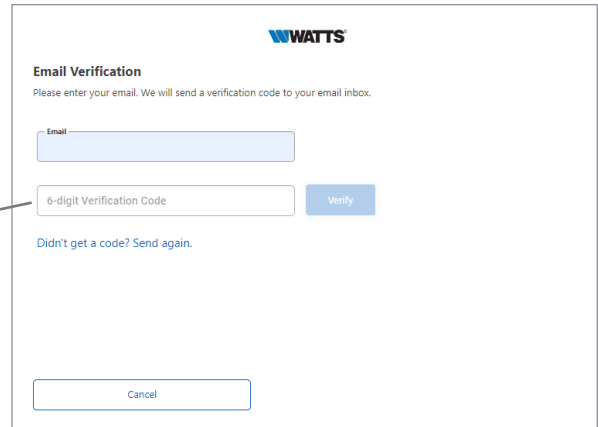

The screenshot shows the 'Email Verification' page of the Watts app. At the top, the 'WATTS' logo is displayed. Below it, the heading 'Email Verification' is followed by the instruction: 'Please enter your email. We will send a verification code to your email inbox.' There are two input fields: 'Email' and '6-digit Verification Code'. A blue 'Verify' button is positioned to the right of the verification code field. Below the input fields, there is a link that says 'Didn't get a code? Send again.' At the bottom of the form, there is a 'Cancel' button.

Login

Click the Sign In button to login to the app using your Watts account email address and password.

Watts uses Microsoft Azure for hosting the web and mobile app services. It is normal for a dialog box to appear asking if you wish to use b2clogin.com to login.

To protect your identity, please keep your password secret and do not share with other users. tekmar® and Watts technical support will not ask you to share your password.

If you forget your password, press "Forgot password". A email will be sent to your account with a link to create a new password.

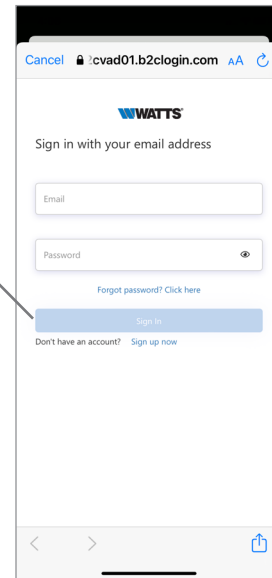

The screenshot shows the login screen of the Watts mobile app. At the top, there is a 'Cancel' button and a browser address bar showing 'cvad01.b2clogin.com'. The 'WATTS' logo is centered at the top. Below the logo, the text 'Sign in with your email address' is displayed. There are two input fields: 'Email' and 'Password'. A link for 'Forgot password? Click here' is located below the password field. A blue 'Sign In' button is positioned below the input fields. At the bottom, there are two links: 'Don't have an account? Sign up now'.

Add a Building

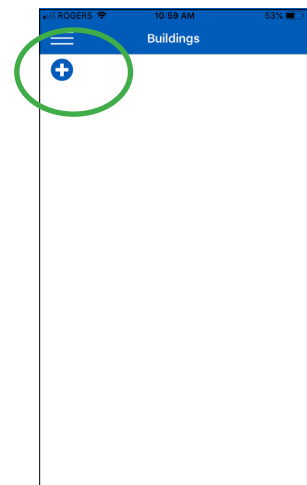
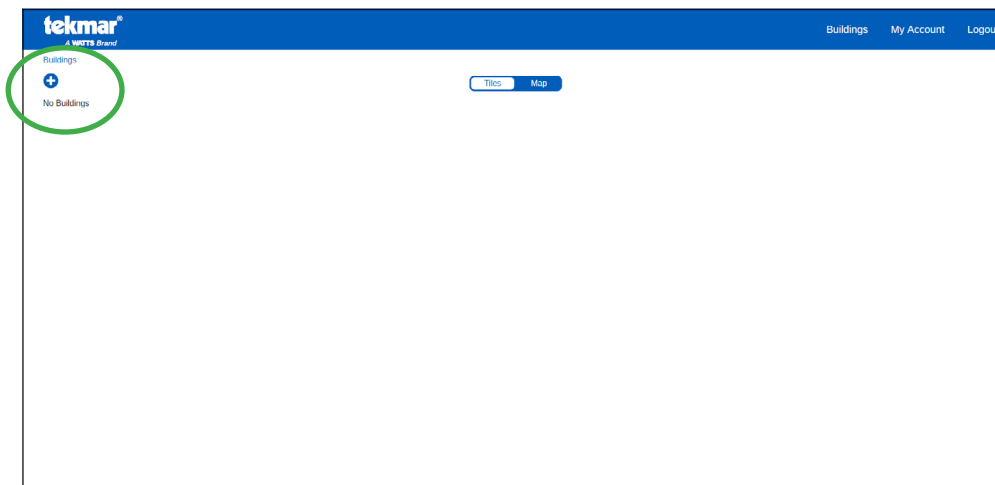

- Press the + button to add a new building.
- When you first log in, there will usually be no buildings linked to your account. The exception is when a building administrator shares building access through an email.
- Each tekmarNet Gateway 486 represents a building on the web or mobile app.
- When you Add a Building, your account becomes the building Administrator.
- The building Administrator can share access to other user accounts by sending an invitation email. See Adding Users section.

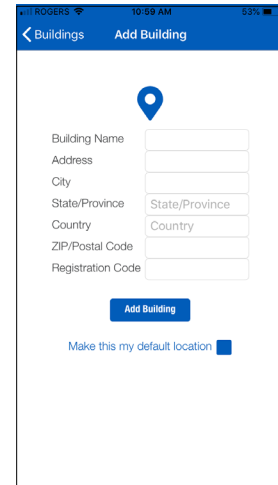
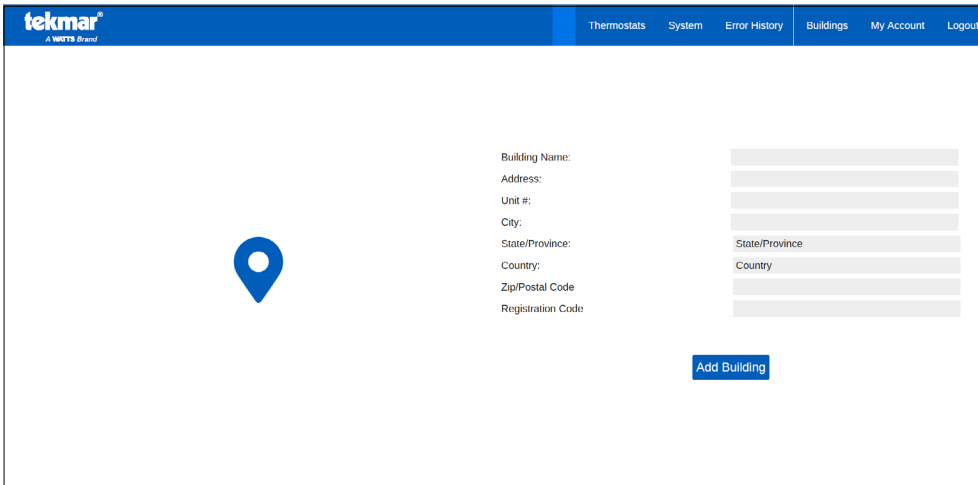

- Each building requires the following information: building name, address, unit or suite number, state or province, country and ZIP or Postal Code.
- Enter the 8-digit registration code from the tekmarNet Gateway 486. See steps below.
- On the web or mobile app, press the Add Building button.

Registration Code

1. From the Home screen, press the Gear symbol

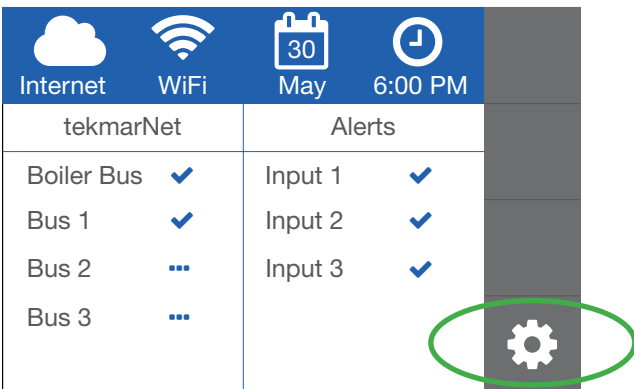

3. Press the Register button

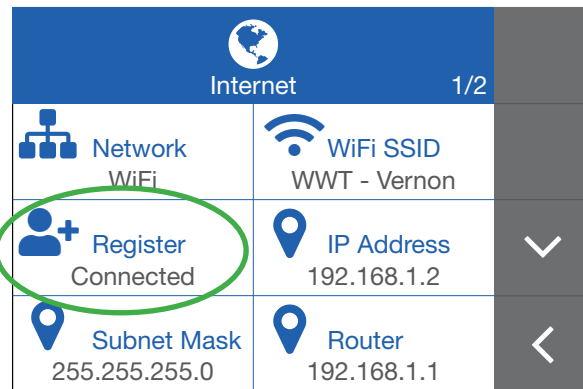

2. Press the Internet button

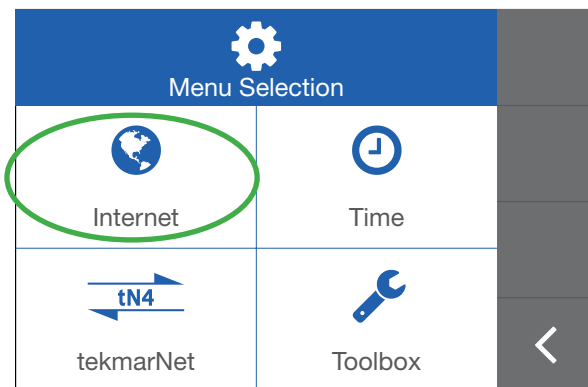

4. Enter the Registration Code into the web or mobile app. The code is valid for 30 minutes.

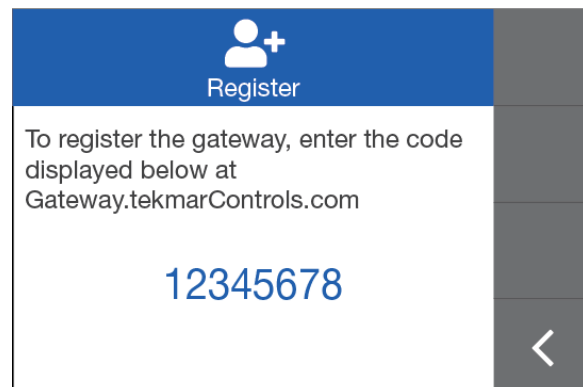

Buildings List

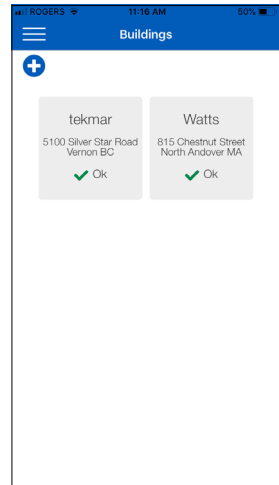
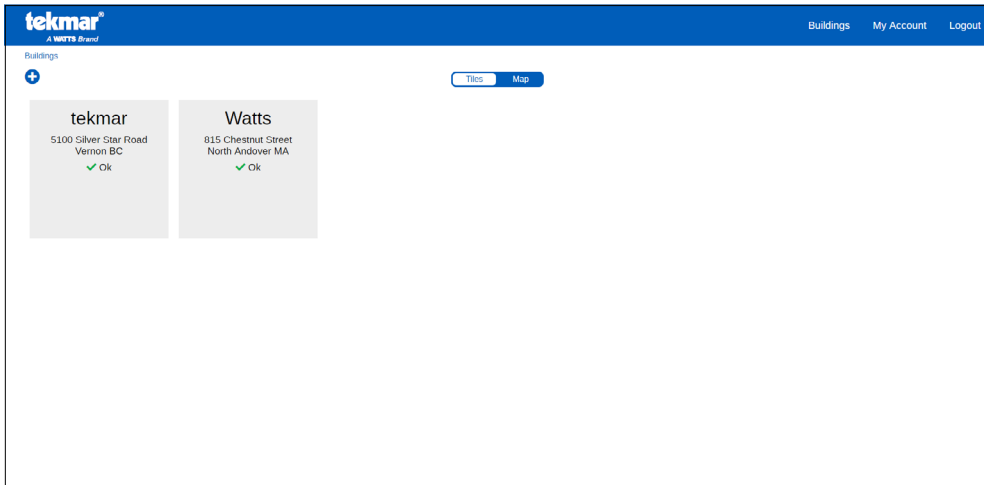

Each building is displayed on the screen as a tile with the building name, address and status. If there are no active errors the status is Ok ✓. When an error condition is present, an Alert ⚠️ is displayed.

Buildings Map

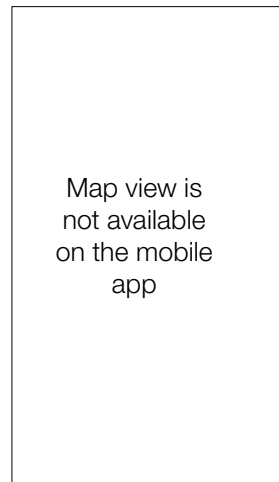
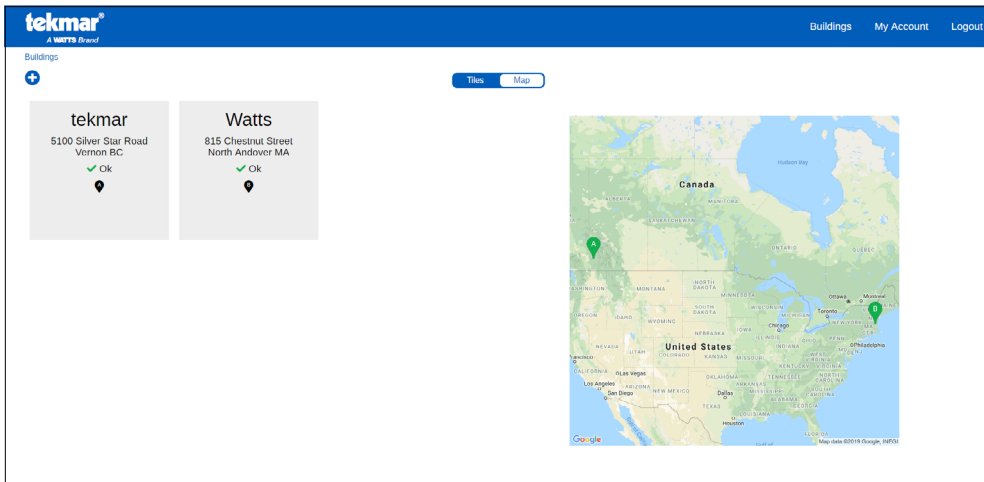

In Map view, the location of each building is displayed as a location pin 📍 on a map.

Edit or Remove Building

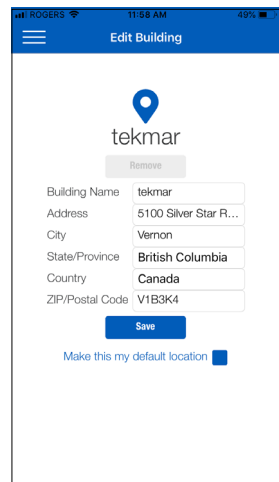
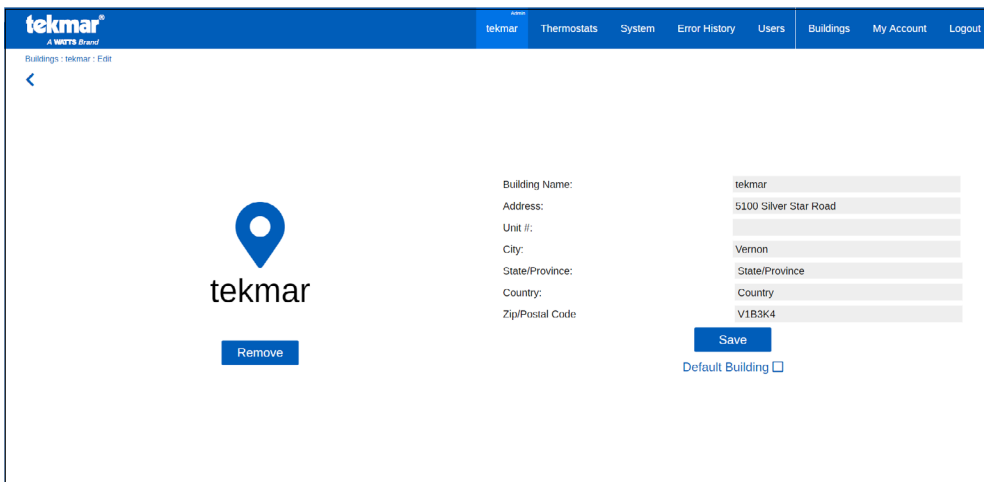

- The Administrator can edit the building information by clicking the building name tab (web) or the pencil ✎ (mobile).
- The Administrator, Installer and User can remove a building from their account.
- A default building can be selected. Select “Default Building” or “Make this my default location.”

Access Levels

Registering a tekmarNet Gateway 486 to your account makes you the building Administrator. The Administrator can share access to a building to other users through an invitation email. Two access levels are available: Installer, and User. Once the invitee creates an account (see Step 5 on pg.15), the invitee account is listed on the Administrator's Users page. For privacy reasons, invitees are unable to view the other accounts with access to the building.

Building Users

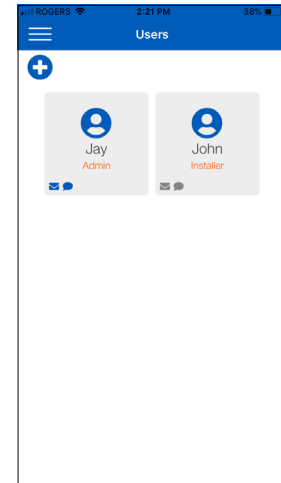
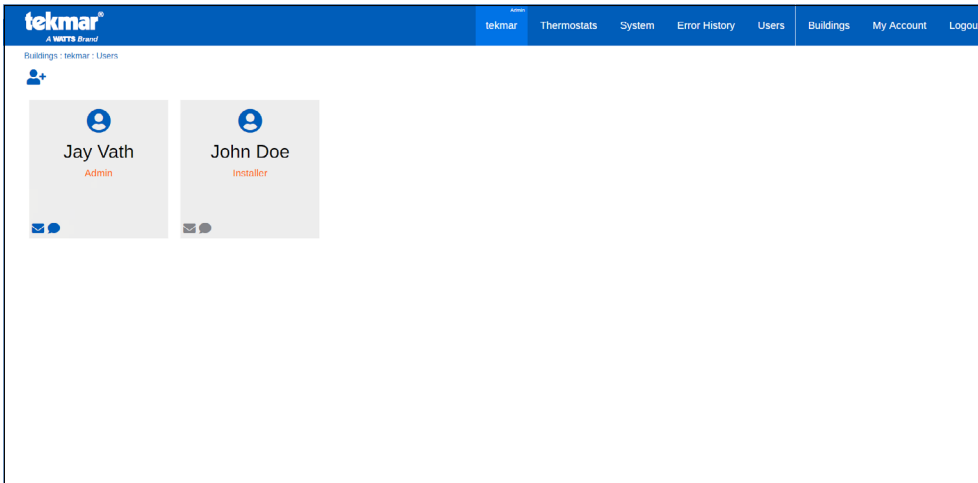

- If you are the Administrator, the menu bar will show a User tab. Press the User tab to view a list of all the users.
- To invite a user to a building, press the button.
- In the tile lower left corner, if the symbol is blue, then the account receives error notifications by email.
- If the symbol is blue, then the account receives error notifications by text message.

Adding a User

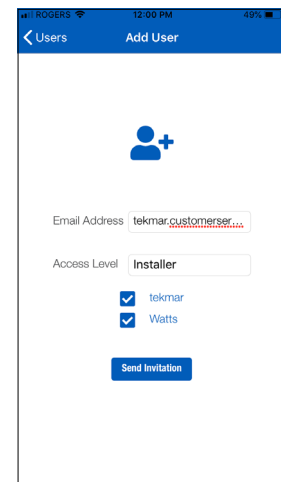
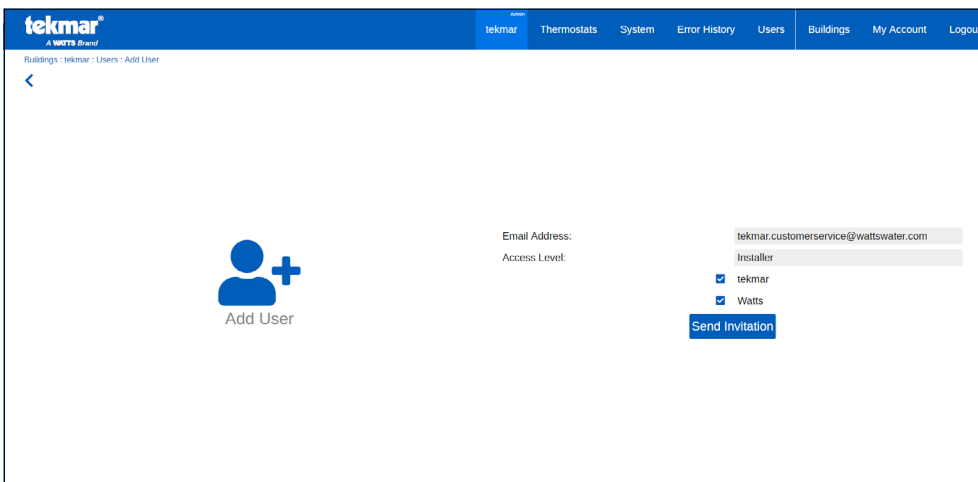

- To invite other users, the Administrator enters the invitee's email address, selects either Installer or User access level permissions, and can select to share access to one or more buildings.

Edit or Remove a User from a Building

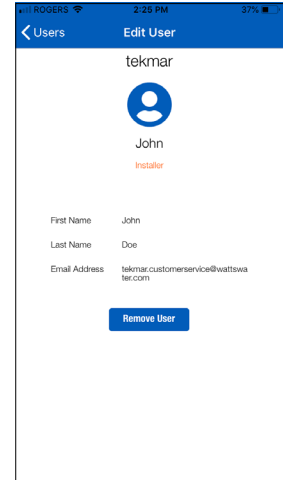
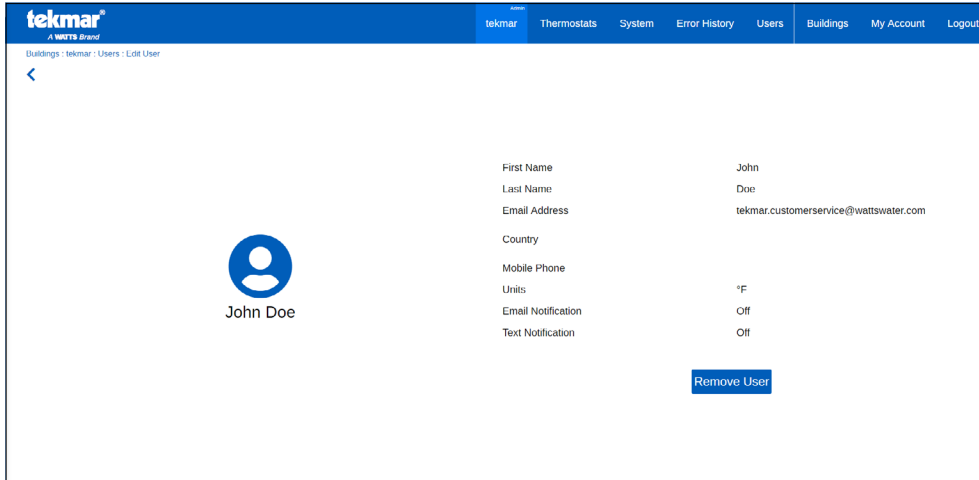

- The Administrator can remove users from a building.
- To remove a user, go to Users, click on a users tile, and then click the Remove User button.

Editing or Delete My Account Settings

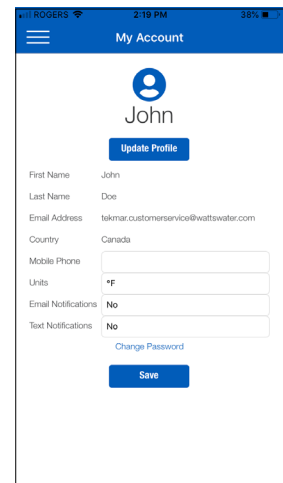
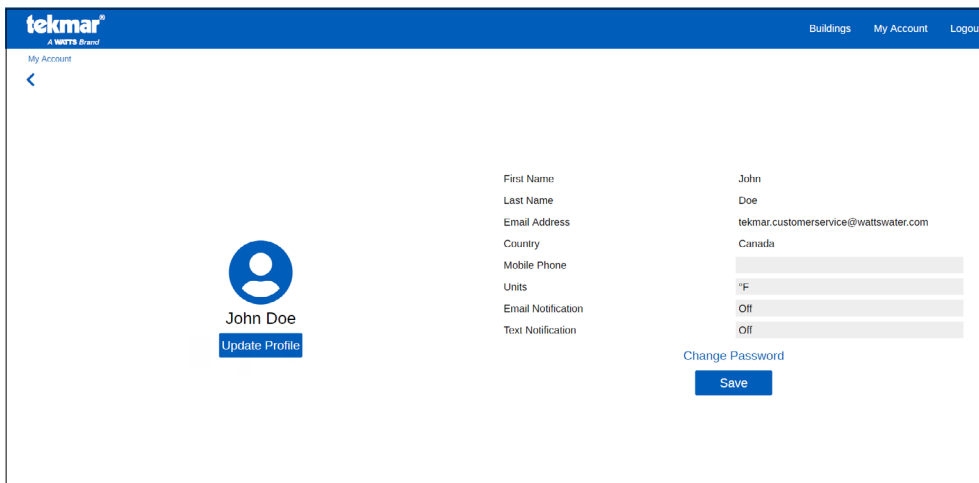

- The My Account settings allow users to change their mobile phone number, preferred temperature units between °F or °C, and select email and/or text message notifications.
- Users can change their first and last names and their country of residence by clicking the Update Profile button.
- Users can request to delete their account by clicking Update Profile button.

Thermostat List

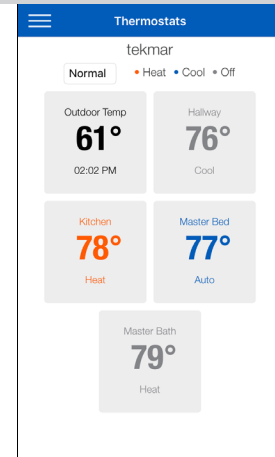
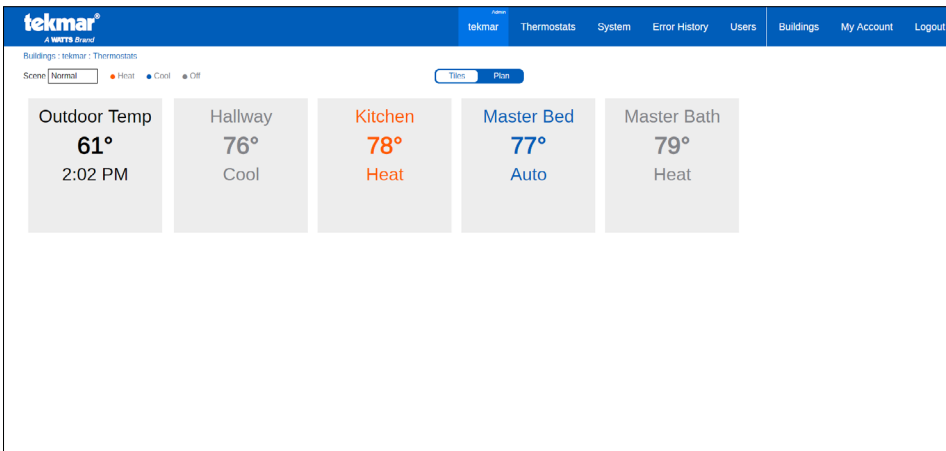

- Each thermostat is listed as a tile, with the thermostat name, temperature and mode (heat, cool, auto, off).
- The information is orange when the HVAC equipment is heating, blue when cooling and gray when off.
- The outdoor air temperature and current local time is displayed in black.
- The scene can be changed from this screen. Select scenes 1 through 8 to change all the thermostat preset temperatures.
- Click on a thermostat tile to view and adjust the thermostat setting.

Thermostat Floor Plan

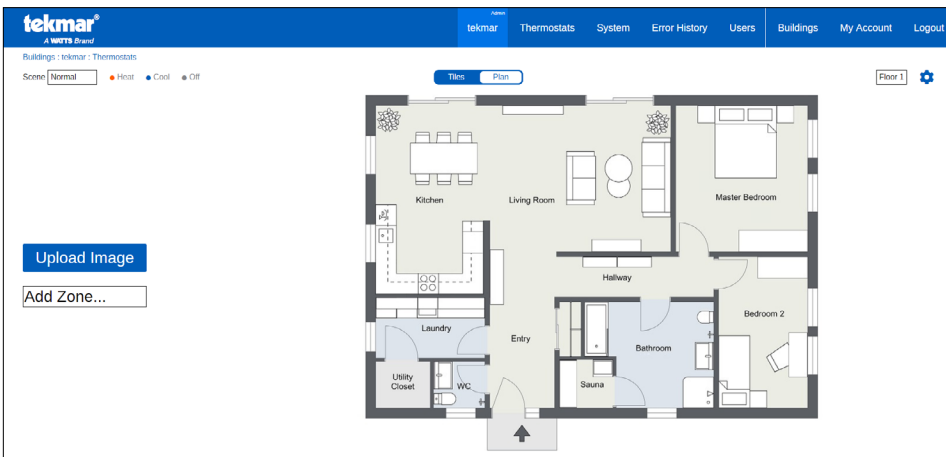

Floor plan is not available on the mobile app

- To use the floor plan, first click the ⚙️ button to setup.
- The installer can upload up to three floor plans, one per building level. The floor plan must be a JPEG, PNG, TIF or GIF image file. To create an image file from a PDF, please use a screen capture tool or print screen button on your computer.
- For each thermostat, click the Add Zone button, select the thermostat name and drag it on the floor plan.
- Click the ⚙️ button to save.

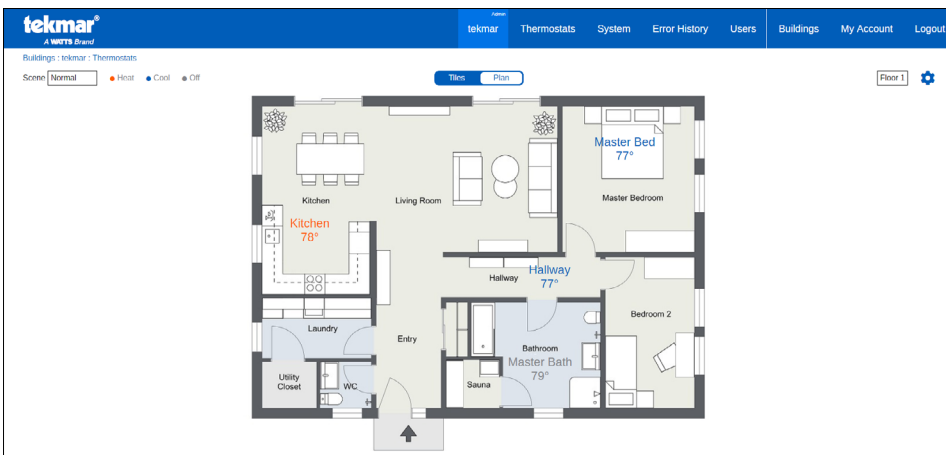

Floor plan is not available on the mobile app

- Once setup, the thermostat name and temperature is listed on the floor plan. Click to adjust the thermostat settings.
- Use the floor plan drop down menu to select the desired building level.

Thermostat Temperature

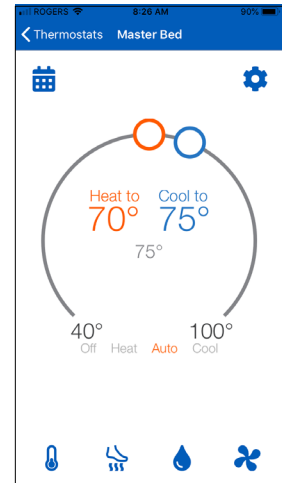
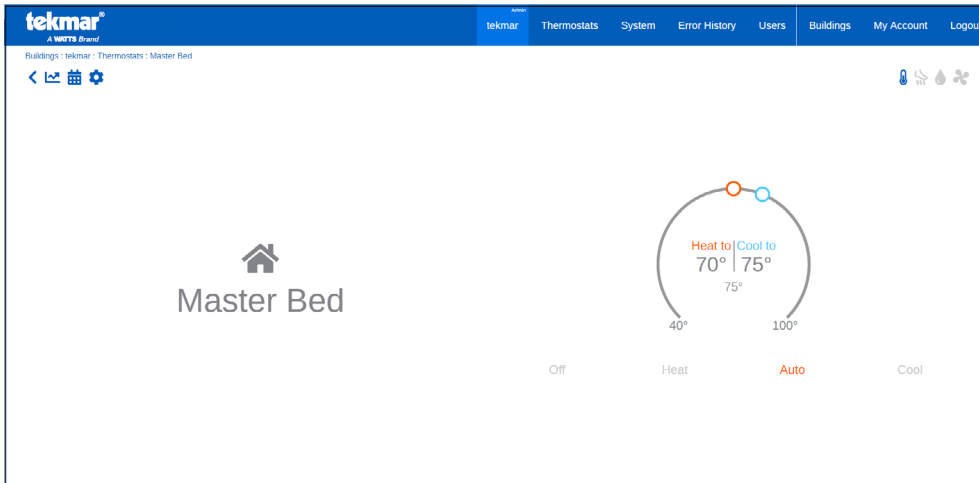

- The thermostat temperature is shown in the center of the horseshoe slider.
- Adjust the thermostat temperature by adjusting the orange (heating) or blue (cooling) circles.
- The current mode (heat, cool, off, auto) is shown in orange. To change, click on the desired mode.

Thermostat Floor Temperature

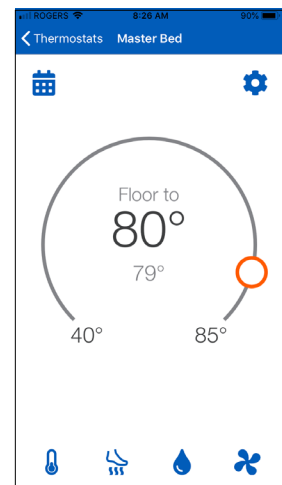
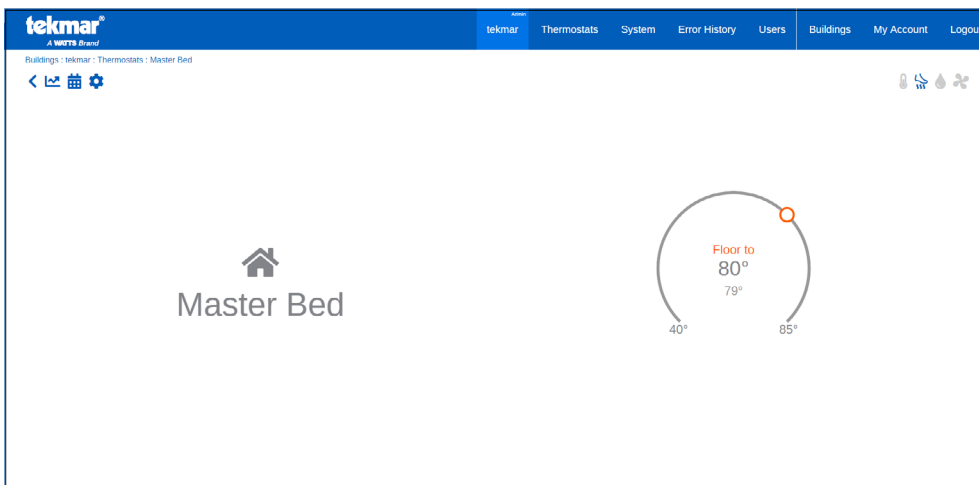

- Click the floor heat  button to adjust the floor heating temperature (only available for radiant floor heating with a floor sensor).

Thermostat Relative Humidity

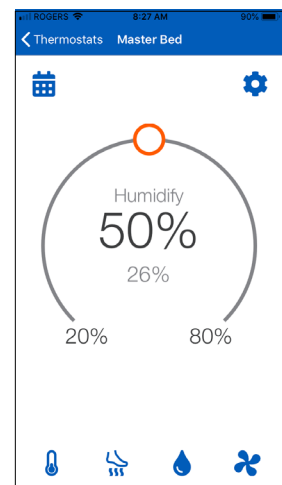
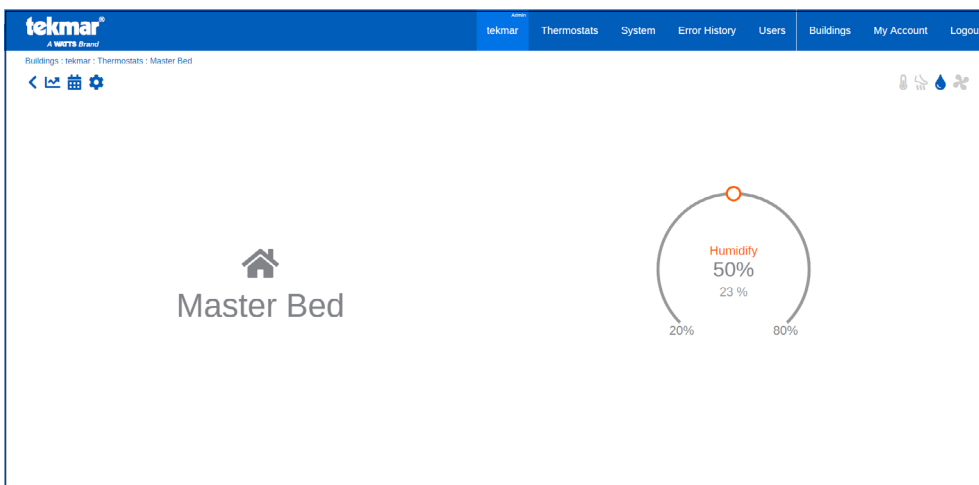

- Click the water drop  button to adjust the humidity min and max settings (only available on select thermostat models).

Thermostat Fan

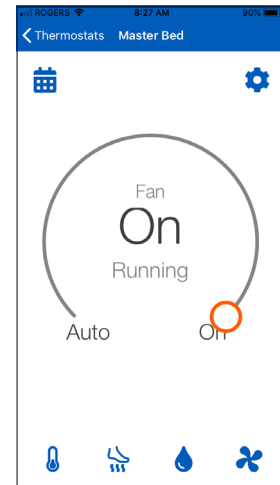
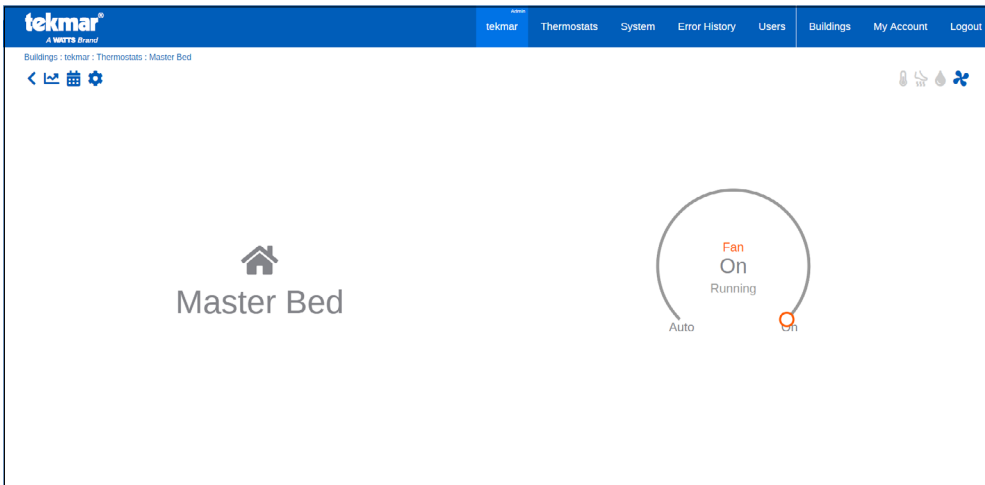

- Click the fan  button to adjust the fan.
- Fan adjustment is between Off or Auto, or between Off, 10 to 90%, Auto depending on thermostat model and configuration.

Thermostat Settings

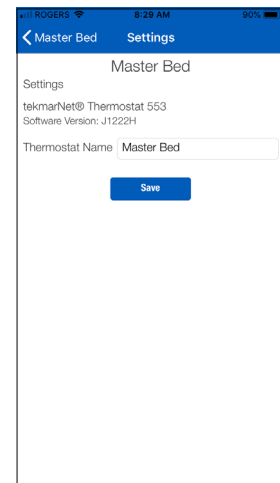
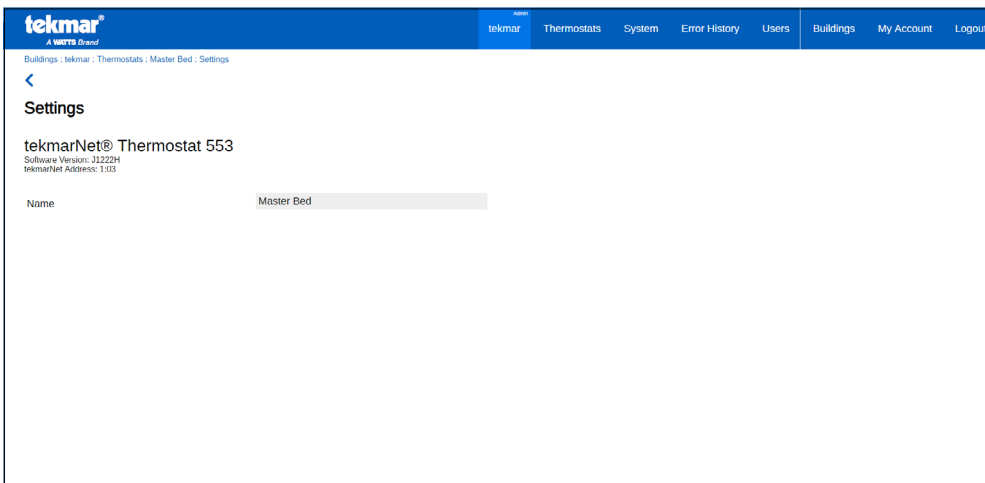

- Click the  button to view the thermostat model, tekmarNet address and change the thermostat name. The name is limited to 16 characters.

Thermostat Schedule

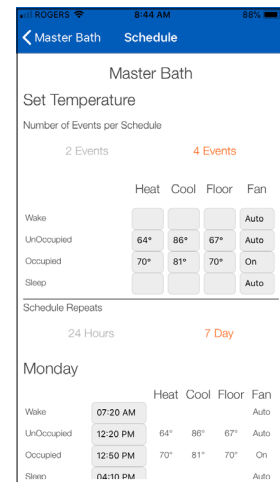
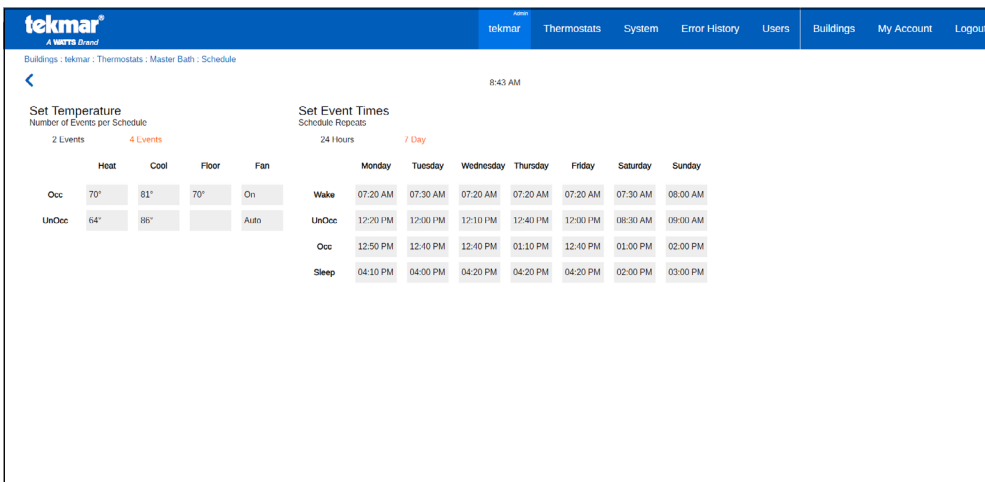

- Click the  button to view and adjust the thermostat schedule.
- The schedule can have 2 or 4 events (temperature changes) per day and repeat either every day (24 hour) or weekly (7-day).

Thermostat Graphing

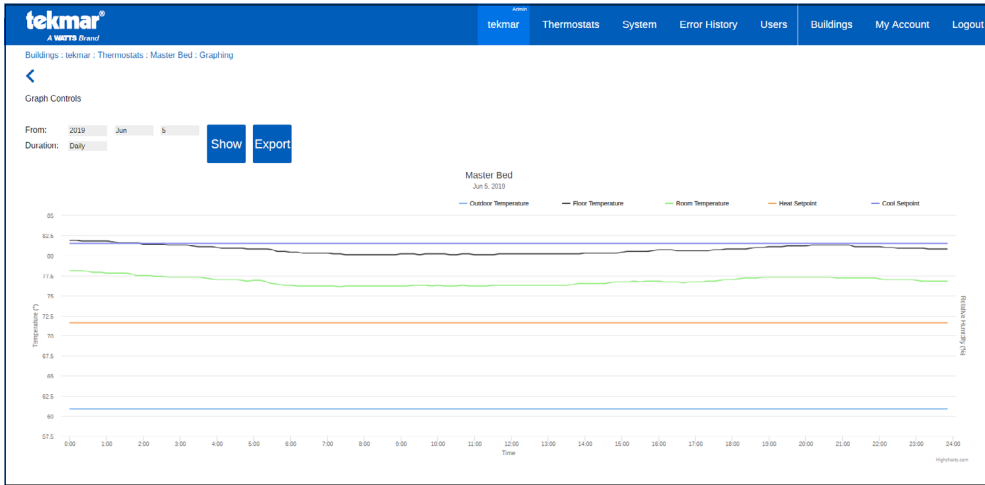

Graphing is not available on the mobile app

- Click the  button to graph the thermostat data.
- Select the time range to be hourly, daily, or monthly.
- Click Show to graph temperatures and setpoints.
- Click on the line color legend to show or hide the line on the graph.
- Click Export to download a CSV format data file which can be opened in a spreadsheet.

Hydronic System Overview

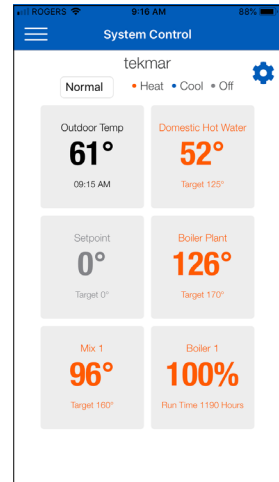
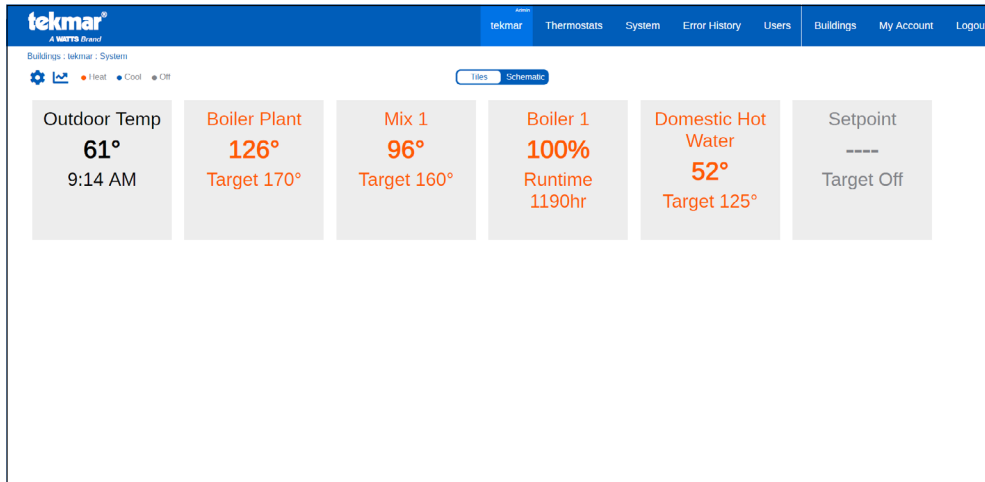

- The system information displayed is dependent on the hydronic control's model and configuration.

Hydronic System Schematic

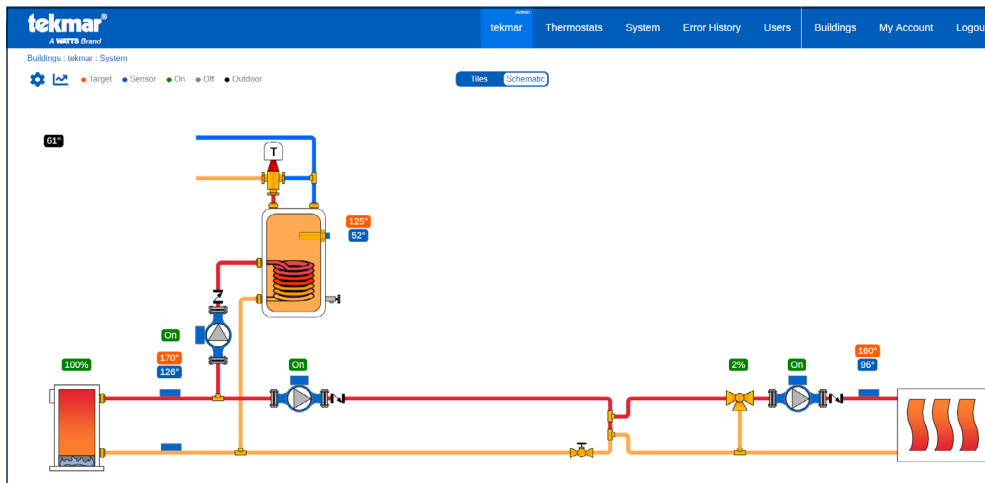

Schematic view is not available on the mobile app

- The system information displayed is dependent on the hydronic control's model and configuration.

Hydronic System Settings

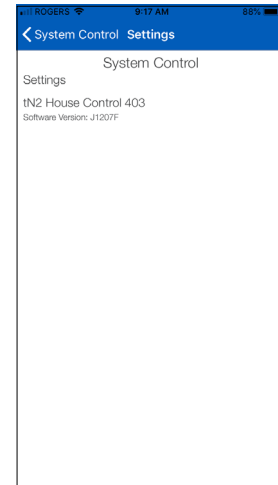
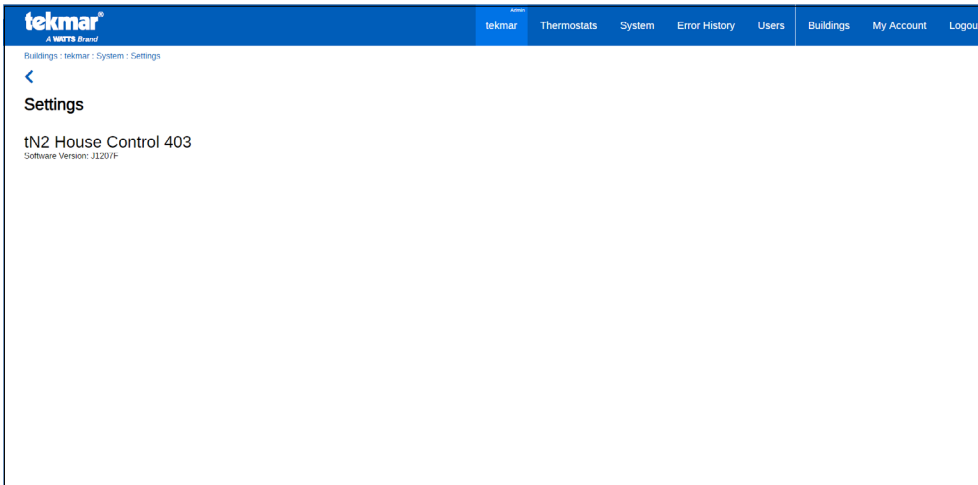

- Click the  button to view the hydronic control's model number and software version.

Hydronic System Control Graphing

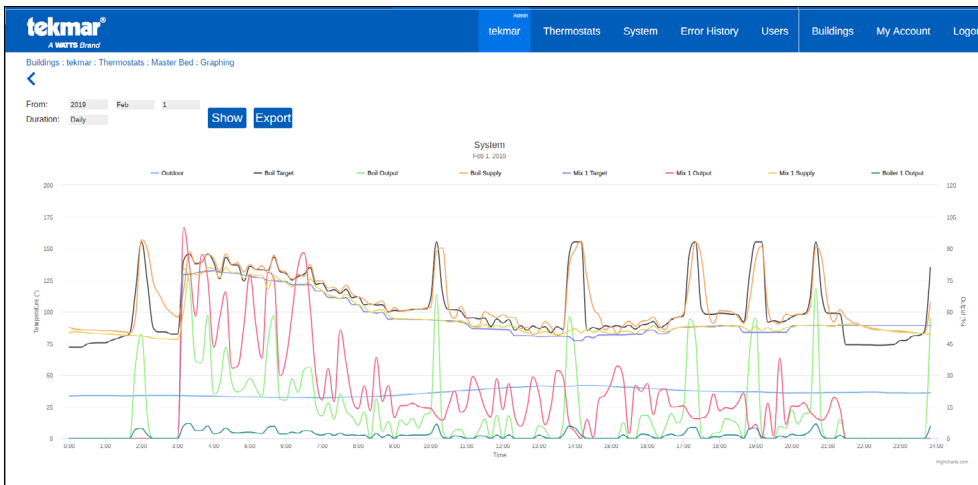

Graphing is not available on the mobile app

- Click the  button to graph the hydronic system data.
- Select the time range to be hourly, daily, or monthly.
- Click Show to graph temperatures and setpoints.
- Click on the line color legend to show or hide the line on the graph.
- Click Export to download a CSV format data file which can be opened in a spreadsheet.

Error Message History

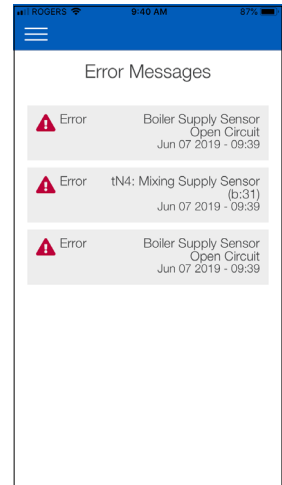
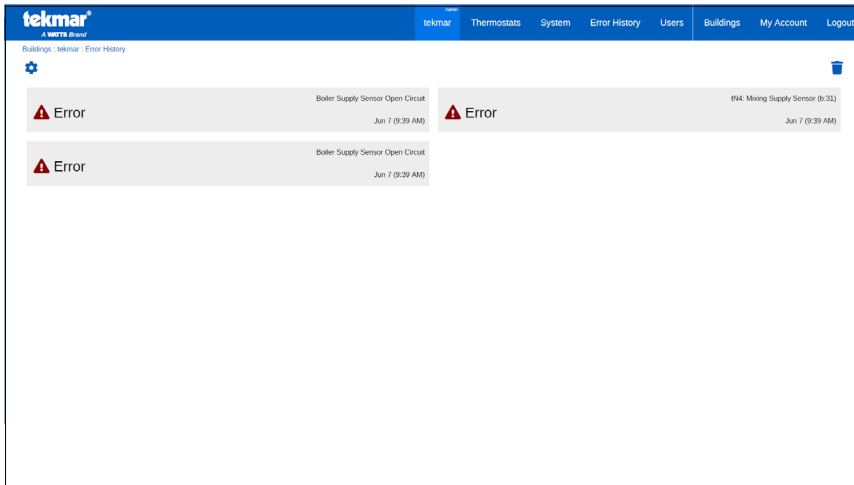

- Errors and warnings are shown together with a time stamp.
- Click the trash can  button to clear all error messages.
- Click the error or warning for detailed description.
- When an error occurs, a notification is sent by email and/or text message to the building's user accounts.

Error Message Description

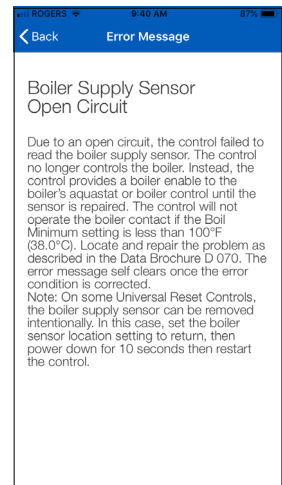
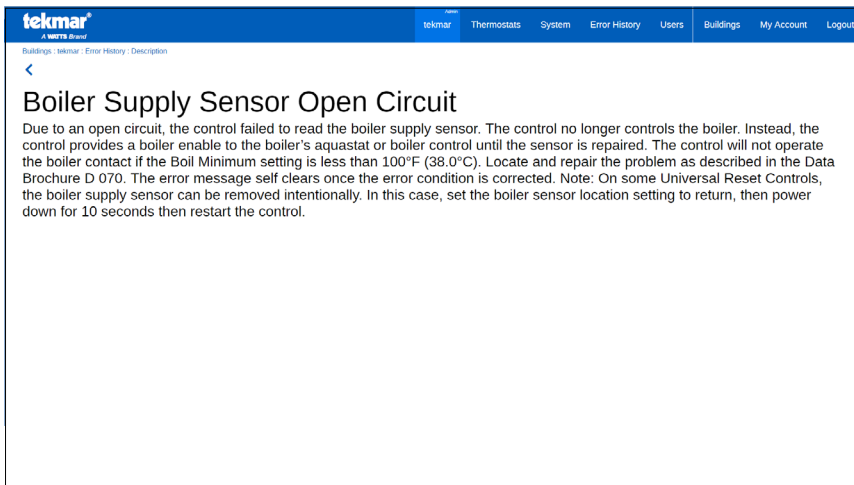

- Follow the instructions on how to clear the error.

Custom Error Message for Alert Inputs

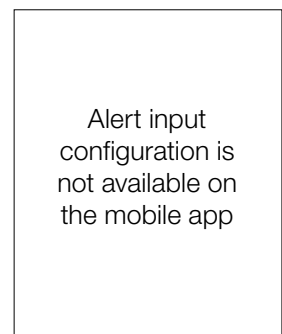
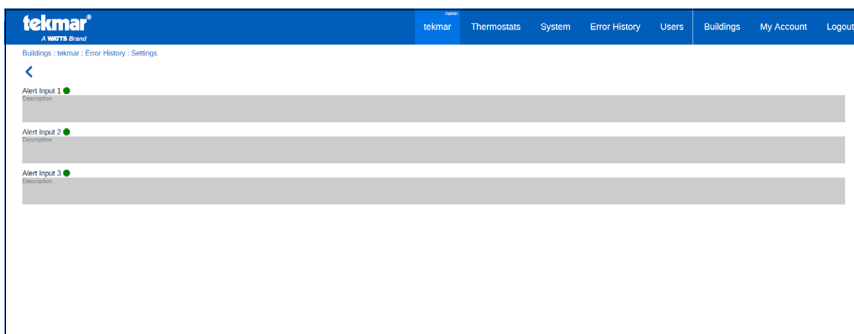

- The tekmarNet Gateway 486 includes three alert inputs to monitor equipment in the boiler room.
- Create a custom notification message that is sent by email or text message when the alert input is activated.

Troubleshooting FAQ

Issue: I am unable to sign in using my email address.

Answer: Check to see if your mobile phone or computer is connected to the Internet.

Issue: I have a WiFi connection but the 486 is not connected to the Cloud.

Answer: Check the router to determine if it has an Internet connection. Also check that the router is not blocking outbound ports 123 (NTP), 4040 (TLS) or 53 (DNS).

Issue: I am creating a new account and the verification code is not working.

Answer: The verification code must be used within 30 minutes or it expires. Please restart the sign up process.

Issue: I am adding a new building and the 8-digit registration code is not working.

Answer: The registration code must be used within 60 minutes or it expires. Go to the tekmarNet Gateway 486 Internet menu and obtain a new registration code.

Issue: I am unable to view the list of building users.

Answer: Only the administrator may view the list of building users and invite other users.

Issue: I have an administrator account for a building. How do I transfer administrative access level privileges to another account?

Answer: The tekmarNet Gateway 486 must be deregistered. This requires physical access to the 486. Once deregistered, the 486 may be registered to the new administrator's account.

Issue: What is the maximum number of buildings that can be registered to an account?

Answer: There is no limitation on the number of buildings that can be registered to a user's account.

Issue: I have added a user but they are not listed on the Users page.

Answer: The invitee must sign up and create an account before they will appear in the Users list.

Issue: I made changes to a Setpoint Control 161 and 162 and the information is not up to date on the web or mobile app.

Answer: Unlike newer thermostats, the Setpoint Control 161 and 162 do not automatically report changes to the 486. The 486 must find changes by polling the 161 and 162. It may require up to 10 minutes to update the information.

Technical Data

tekmarNet Gateway 486 <i>Cloud Connectivity with Web & Mobile App</i>	
Literature	Submittal ES-T-486, Installation Operation Maintenance Manual IOM-T-486
Packaged weight	2.9 lb. (1300 g)
Enclosure	Blue PVC plastic, NEMA type 1
Dimensions	6 ⁵ / ₈ " H x 7 ⁹ / ₁₆ " W x 2 ¹³ / ₁₆ " D (170 x 193 x 72 mm)
Display	3.5" color touchscreen
Approvals	Meets Class B: ICES & FCC Part 15, CE, UKCA
Ambient conditions	Indoor use only, 32 to 122°F (0 to 50°C), < 90% RH non-condensing
Power supply	100~240 V(ac) input, 5 V (dc) regulated output, 1 A, center positive, Class 2, FCC certified, CSA or UL listed
Alert inputs	Short, 0 - 30 V (ac)
Ethernet	10/100BASE-T
WiFi	WiFi 802.11n, 2.4 GHz, WPA2 encryption
Mobile app	Apple® iOS 12 or higher, Android™ 10 or higher
Warranty	3 Year Limited Warranty

Warranty

Limited Warranty *The liability of tekmar under this warranty is limited. The Purchaser, by taking receipt of any tekmar product ("Product"), acknowledges the terms of the Limited Warranty in effect at the time of such Product sale and acknowledges that it has read and understands same.*

The tekmar Limited Warranty to the Purchaser on the Products sold hereunder is a manufacturer's pass-through warranty which the Purchaser is authorized to pass through to its customers. Under the Limited Warranty, each tekmar Product is warranted against defects in workmanship and materials if the Product is installed and used in compliance with tekmar's instructions, ordinary wear and tear excepted. The pass-through warranty period is for a period of twenty-four (24) months from the production date if the Product is not installed during that period, or twelve (12) months from the documented date of installation if installed within twenty-four (24) months from the production date.

The liability of tekmar under the Limited Warranty shall be limited to, at tekmar's sole discretion: the cost of parts and labor provided by tekmar to repair defects in materials and / or workmanship of the defective product; or to the exchange of the defective product for a warranty replacement product; or to the granting of credit limited to the original cost of the defective product, and such repair, exchange or credit shall be the sole remedy available from tekmar, and, without limiting the foregoing in any way, tekmar is not responsible, in contract, tort or strict product liability, for any other losses, costs, expenses, inconveniences, or damages, whether direct, indirect, special, secondary, incidental or consequential, arising from ownership or use of the product, or from defects in workmanship or materials, including any liability for fundamental breach of contract.

The pass-through Limited Warranty applies only to those defective Products returned to tekmar during the warranty period. This Limited Warranty does not cover the cost of the parts or labor to remove or transport the defective Product, or to reinstall the repaired or replacement Product, all such costs and expenses being subject to Purchaser's agreement and warranty with its customers.

Any representations or warranties about the Products made by Purchaser to its customers which are different from or in excess of the

tekmar Limited Warranty are the Purchaser's sole responsibility and obligation. Purchaser shall indemnify and hold tekmar harmless from and against any and all claims, liabilities and damages of any kind or nature which arise out of or are related to any such representations or warranties by Purchaser to its customers.

The pass-through Limited Warranty does not apply if the returned Product has been damaged by negligence by persons other than tekmar, accident, fire, Act of God, abuse or misuse; or has been damaged by modifications, alterations or attachments made subsequent to purchase which have not been authorized by tekmar; or if the Product was not installed in compliance with tekmar's instructions and / or the local codes and ordinances; or if due to defective installation of the Product; or if the Product was not used in compliance with tekmar's instructions.

THIS WARRANTY IS IN LIEU OF ALL OTHER WARRANTIES, EXPRESS OR IMPLIED, WHICH THE GOVERNING LAW ALLOWS PARTIES TO CONTRACTUALLY EXCLUDE, INCLUDING, WITHOUT LIMITATION, IMPLIED WARRANTIES OF MERCHANTABILITY AND FITNESS FOR A PARTICULAR PURPOSE, DURABILITY OR DESCRIPTION OF THE PRODUCT, ITS NON-INFRINGEMENT OF ANY RELEVANT PATENTS OR TRADEMARKS, AND ITS COMPLIANCE WITH OR NON-VIOLATION OF ANY APPLICABLE ENVIRONMENTAL, HEALTH OR SAFETY LEGISLATION; THE TERM OF ANY OTHER WARRANTY NOT HEREBY CONTRACTUALLY EXCLUDED IS LIMITED SUCH THAT IT SHALL NOT EXTEND BEYOND TWENTY-FOUR (24) MONTHS FROM THE PRODUCTION DATE, TO THE EXTENT THAT SUCH LIMITATION IS ALLOWED BY THE GOVERNING LAW.

Product Warranty Return Procedure All Products that are believed to have defects in workmanship or materials must be returned, together with a written description of the defect, to the tekmar Representative assigned to the territory in which such Product is located. If tekmar receives an inquiry from someone other than a tekmar Representative, including an inquiry from Purchaser (if not a tekmar Representative) or Purchaser's customers, regarding a potential warranty claim, tekmar's sole obligation shall be to provide the address and other contact information regarding the appropriate Representative.

Need help? Go to our website or contact us.

tekmarControls.com | tekmar.customerservice@wattswater.com | 1-800-438-3903



A WATTS Brand